

DIE FENSTERCONNECTION

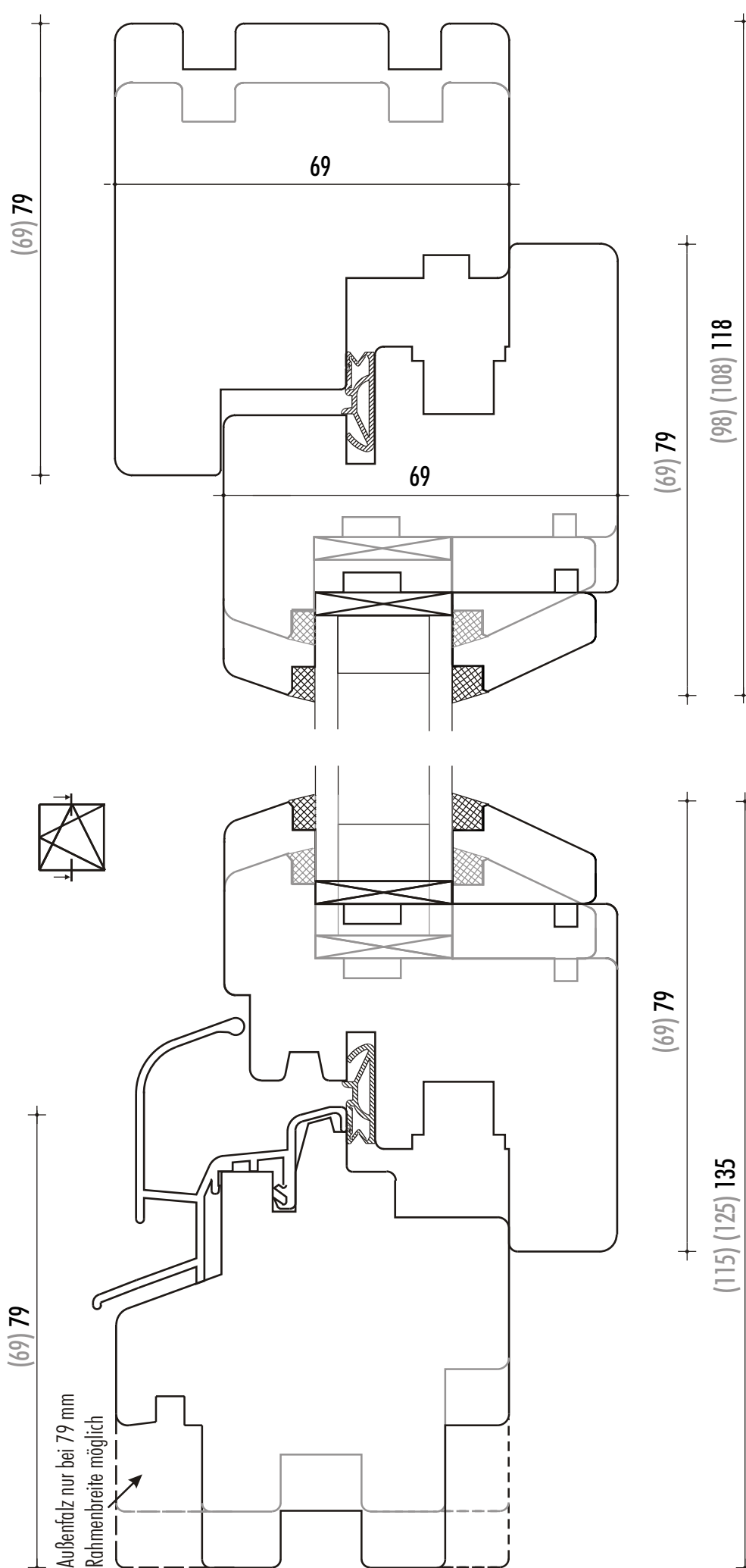

Typ BS und BST

Standard Dreh-Kipp
Fenster und -tür

Blendrahmen
und Flügel
oben und unten
(seitlich wie oben)

Breite und schmale
Profile

DIE FENSTERCONNECTION

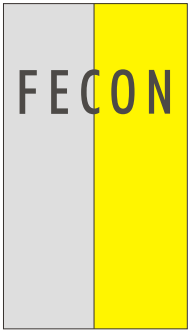
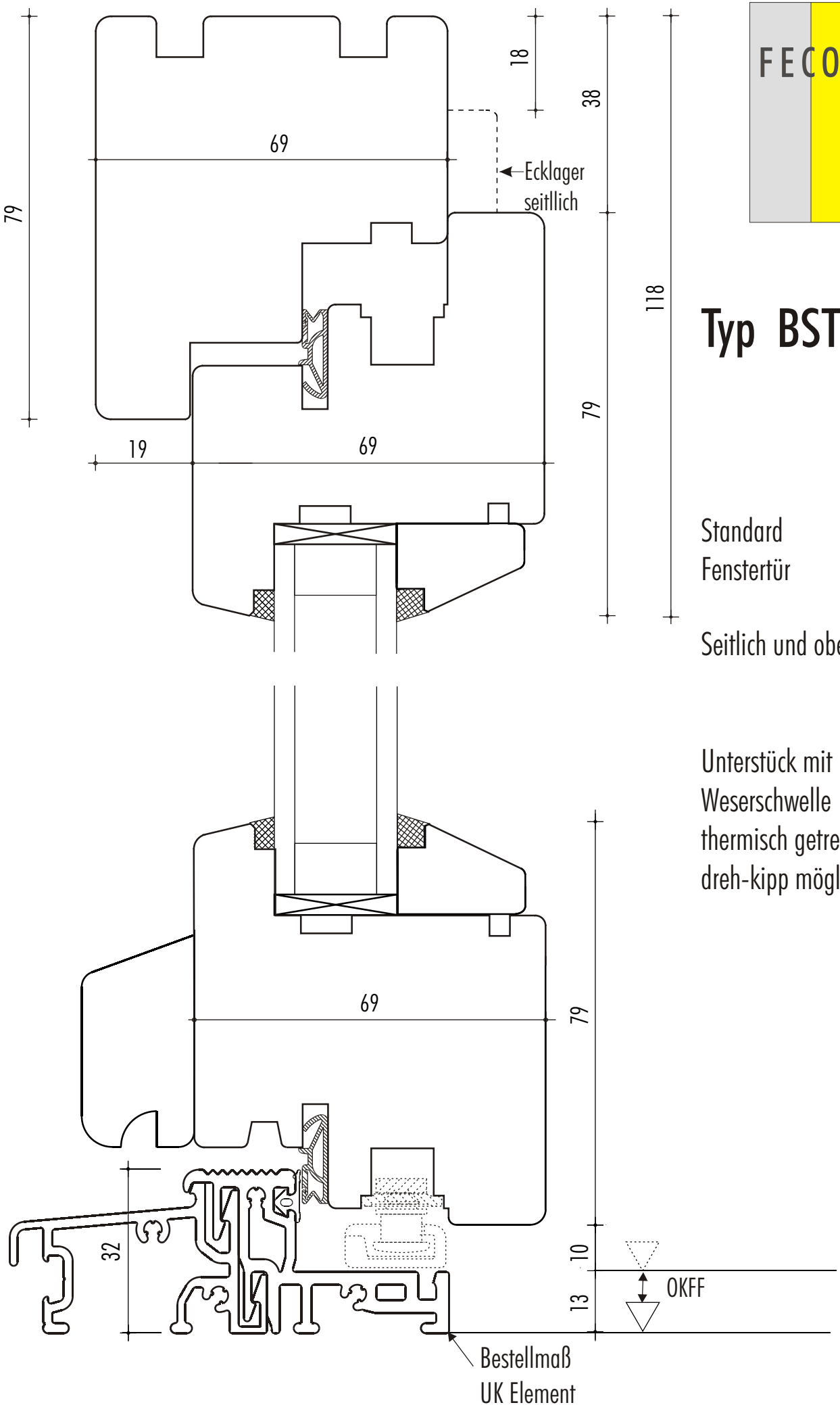

Typ BST

Standard
Fensterür

Seitlich und oben

Unterstück mit
Weserschwelle
thermisch getrennt
dreh-kipp möglich

DIE FENSTERCONNECTION

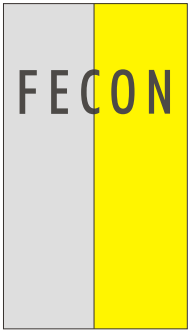
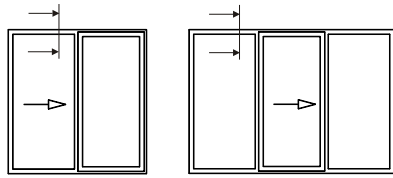

Typ BPS

Parallel-Schiebe-
Kipp-Tür

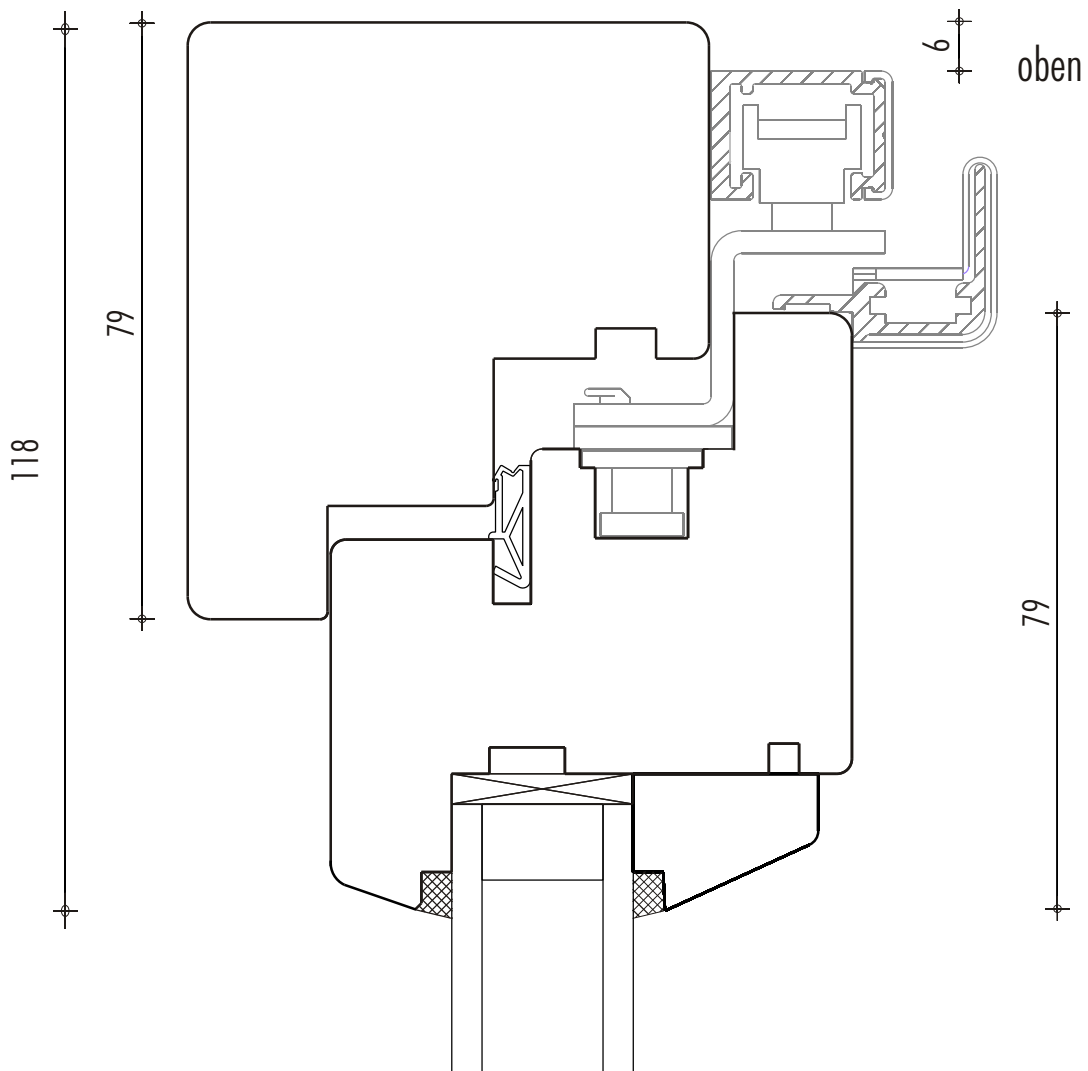

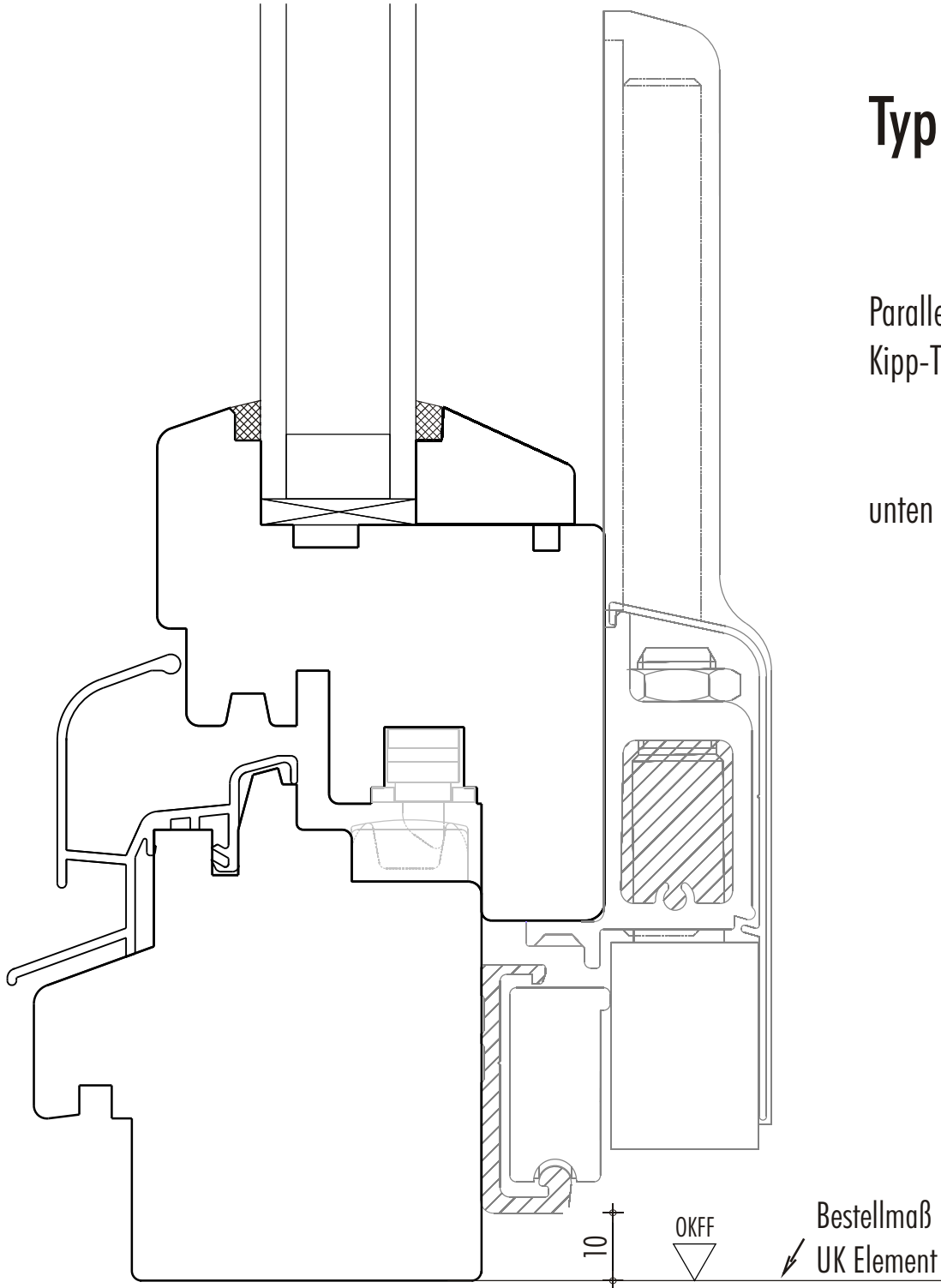
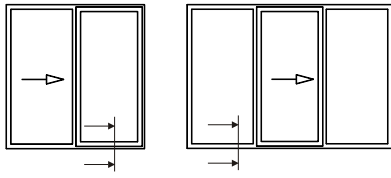
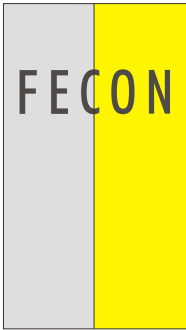

Typ BPS

Parallel-Schiebe-
Kipp-Tür

unten

DIE FENSTERCONNECTION

106

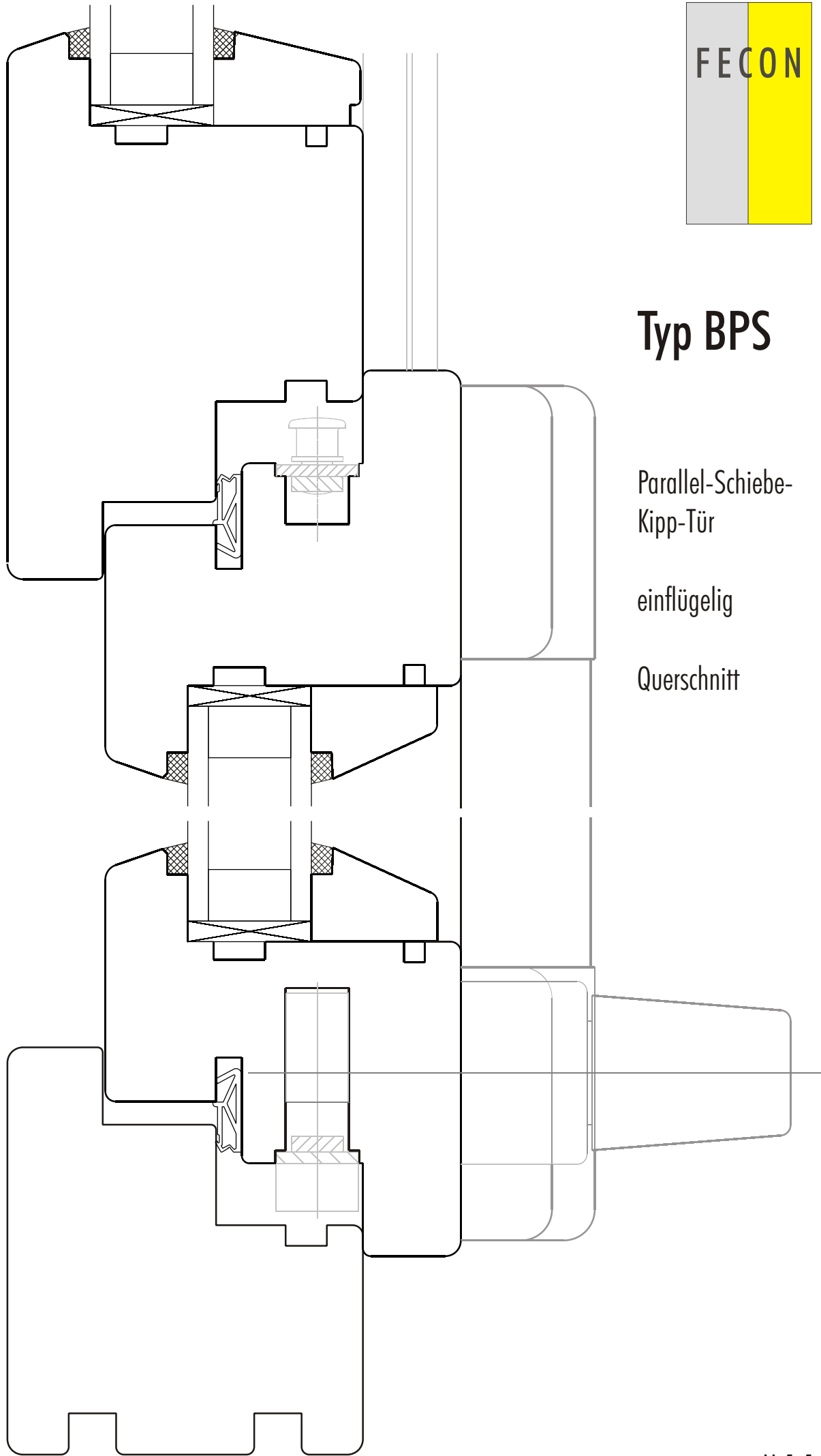

Typ BPS

Parallel-Schiebe-
Kipp-Tür

einflügelig

Querschnitt



321

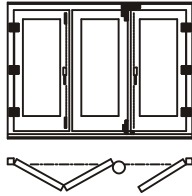

330

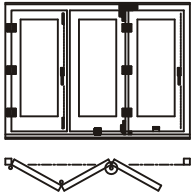

431

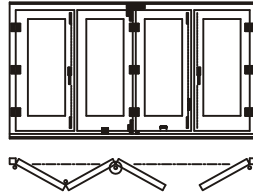

440

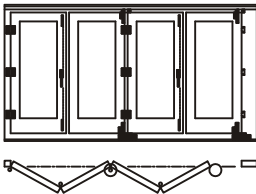

550

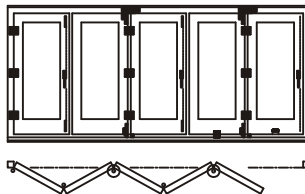

532

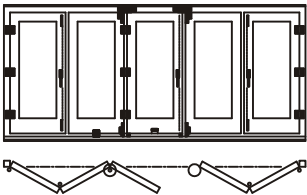

541

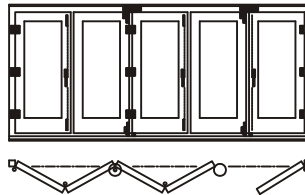

633

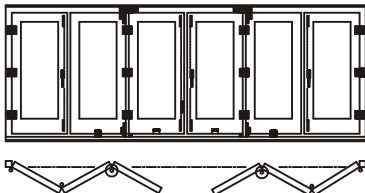

651

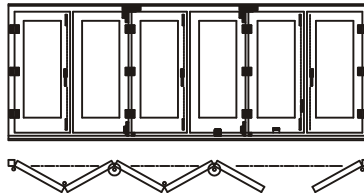

660

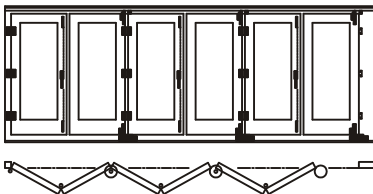

761

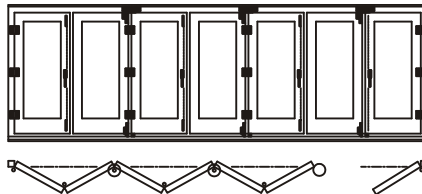

770

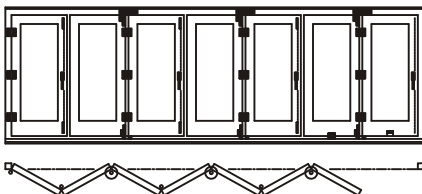

743

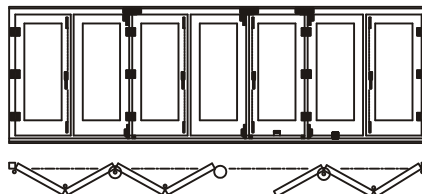

Typ BSFT

Falttür

Faltschema

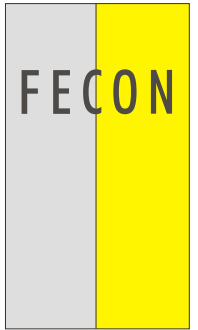
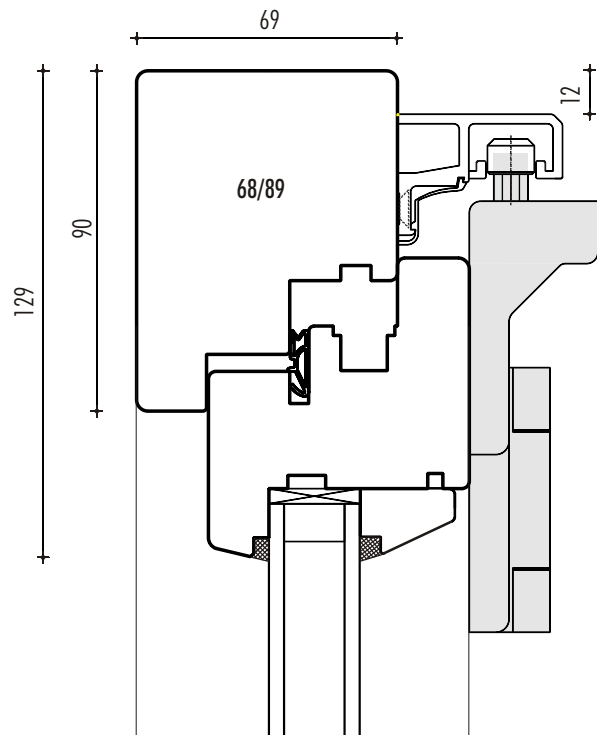
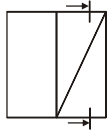

Typ BSFT

Falttür

Metallschwelle

Laufschiene
unten

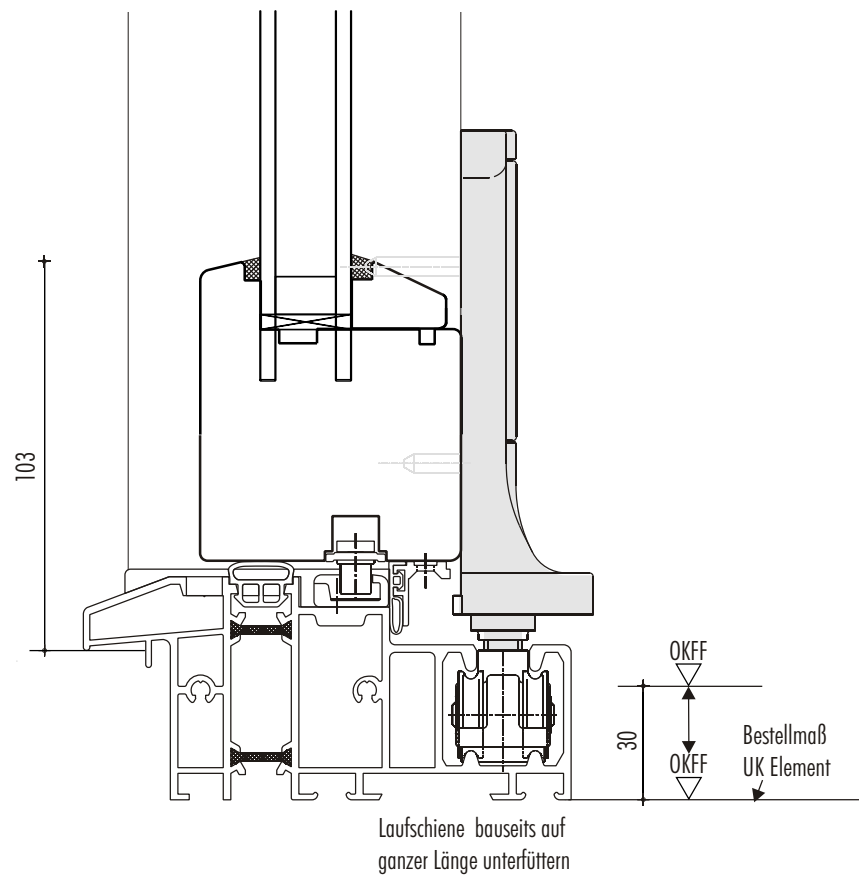

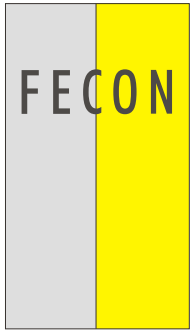
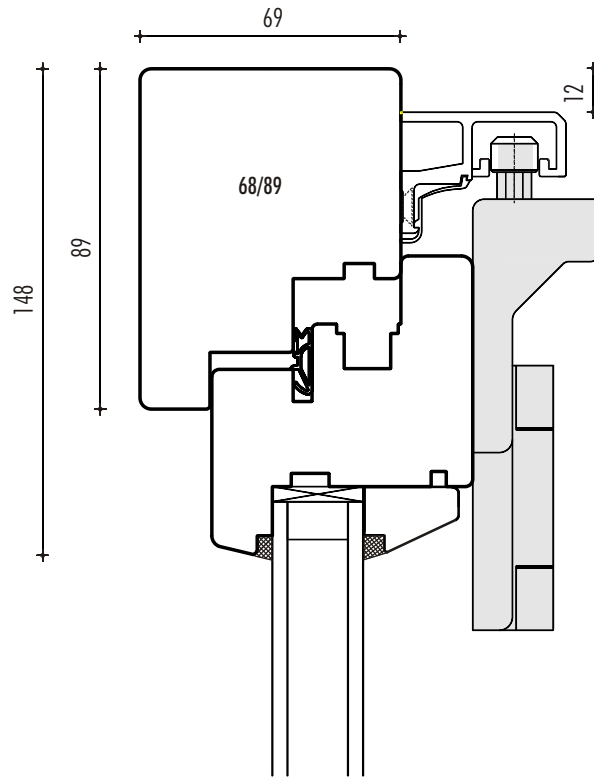

Typ BSFT

Falttür

Holzschwelle

Laufschiene
unten

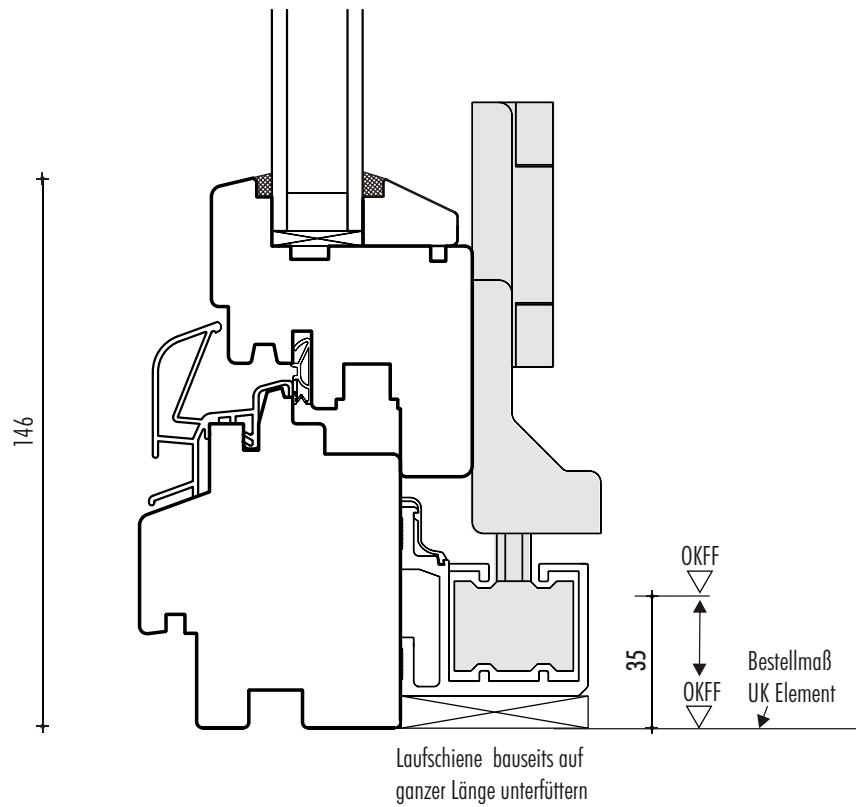

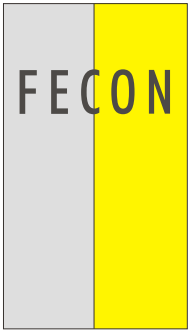
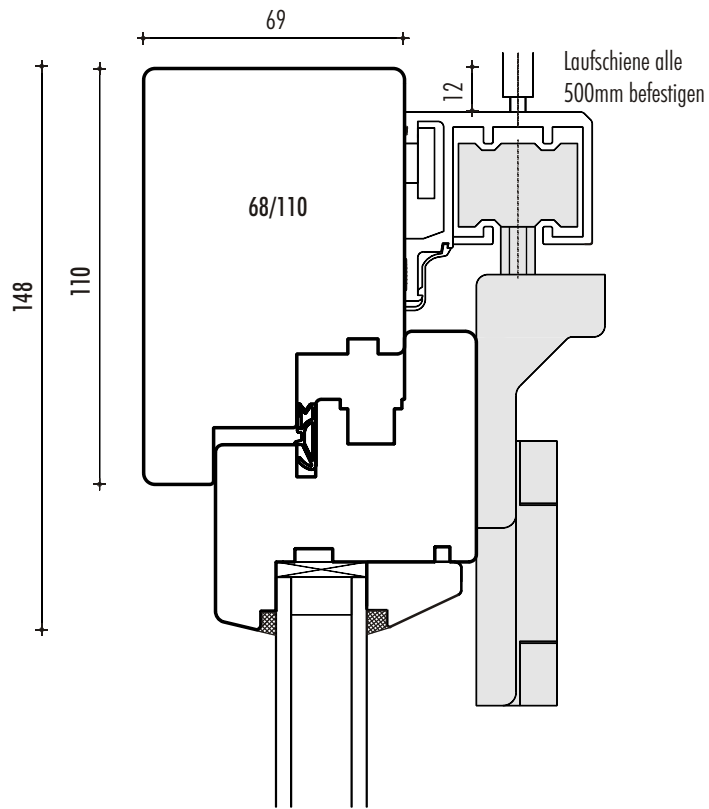
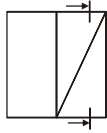

Typ BSFT

Falttür

Holzschwelle

Laufschiene
oben

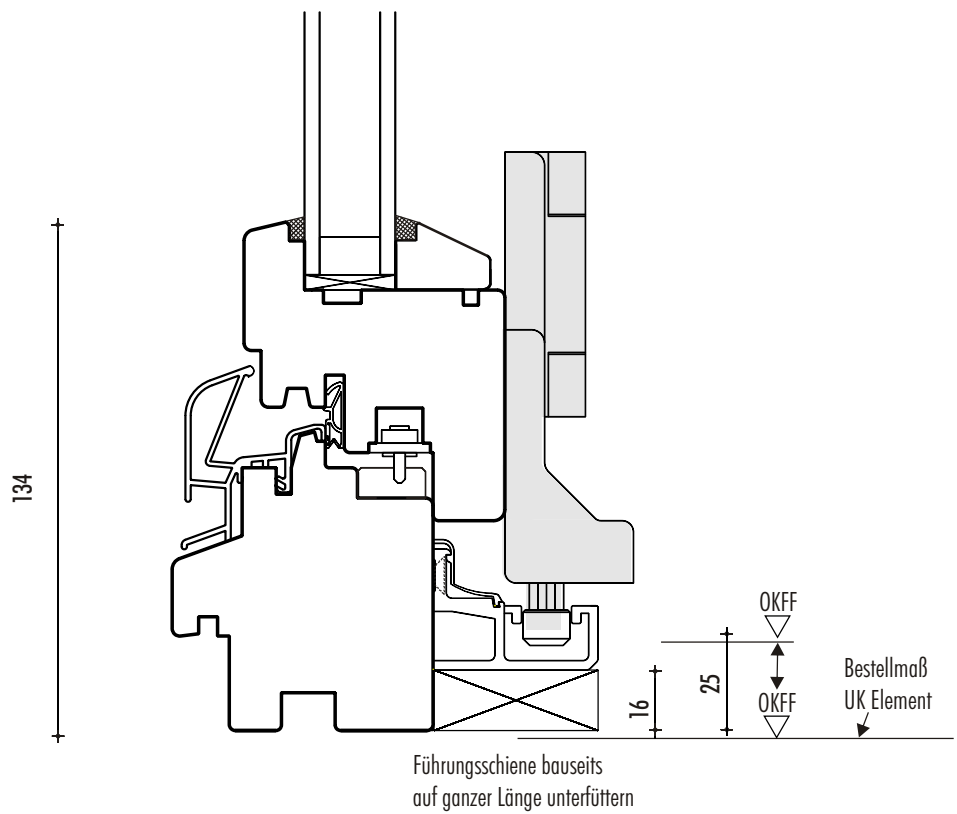

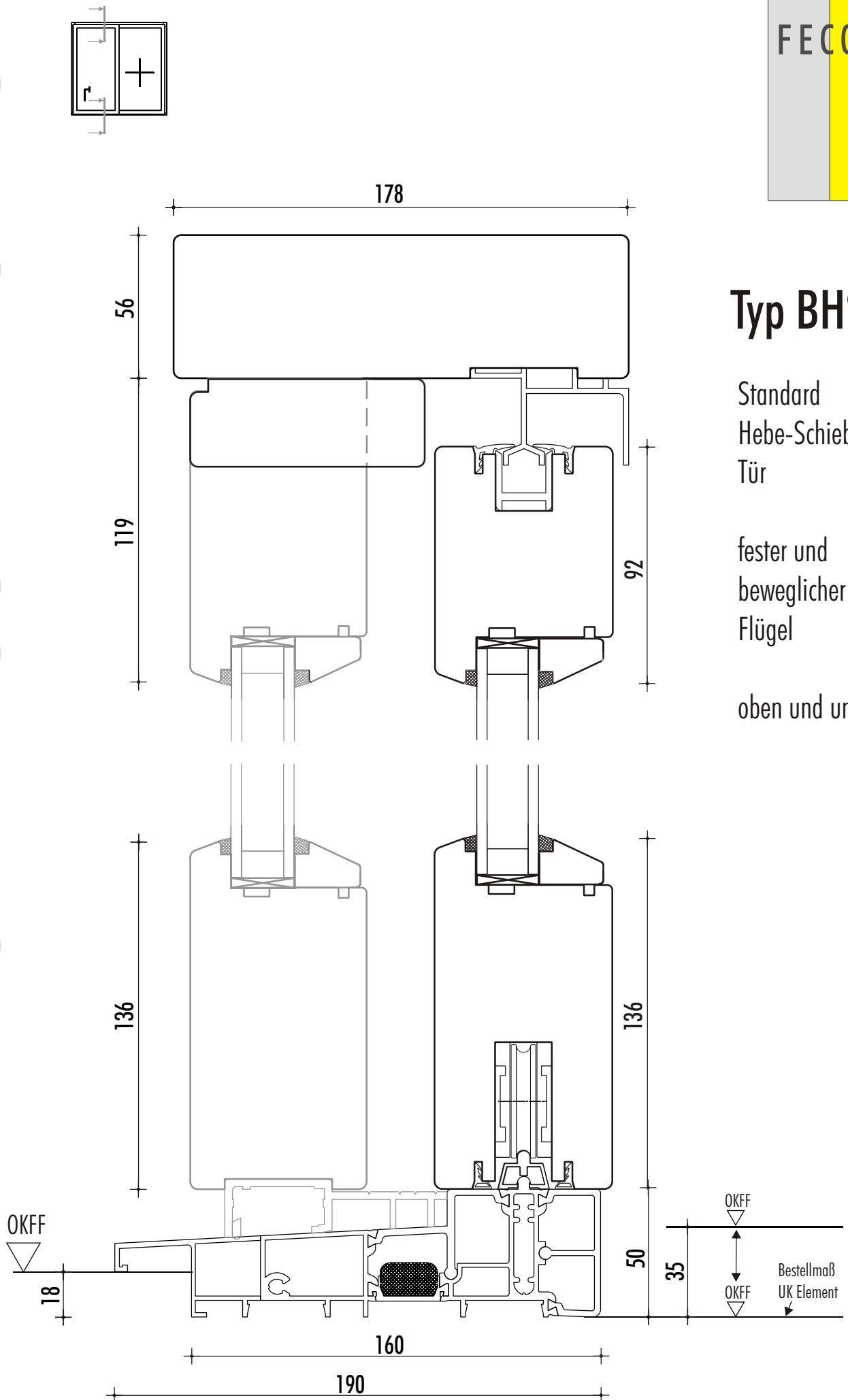
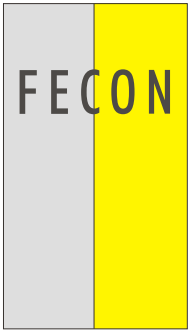

Typ BHST

Standard
Hebe-Schiebe
Tür

fester und
beweglicher
Flügel

oben und unten

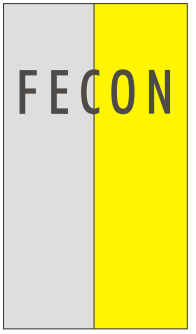

Typ BH

Standard - Haustür
einwärtsschlagend

Unterstück
Aufdoppelung

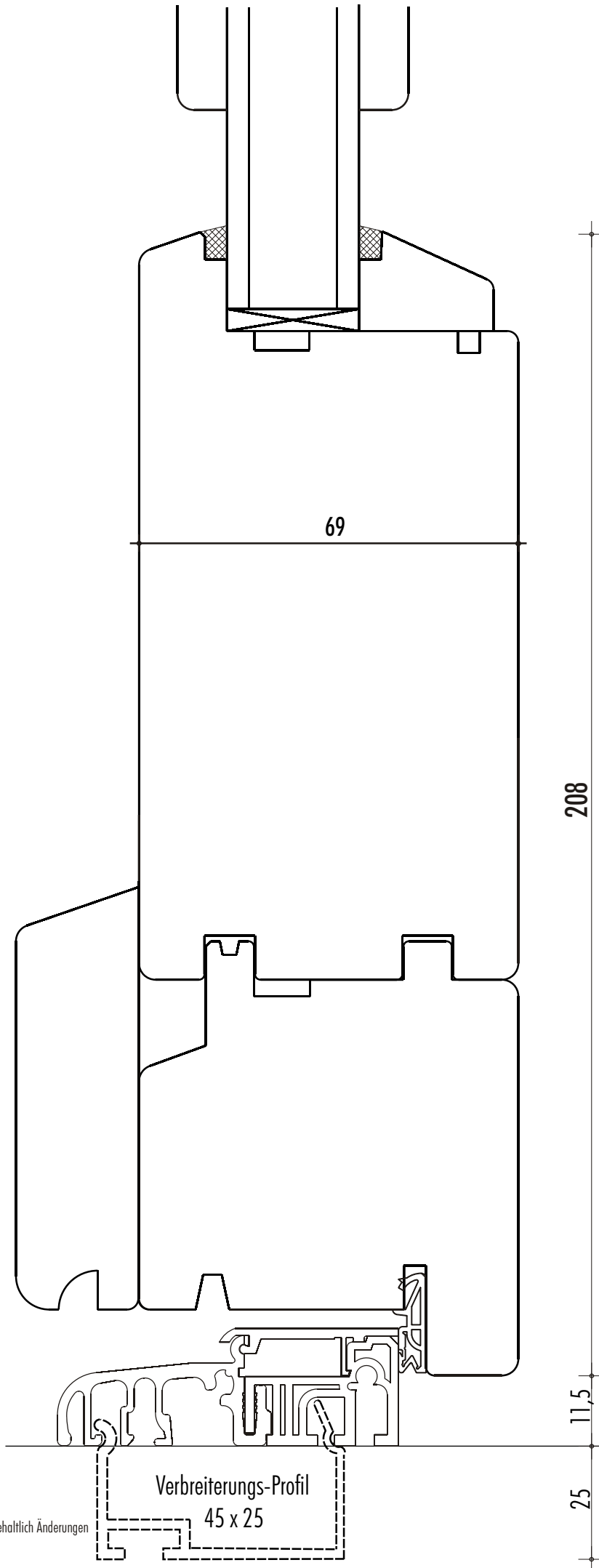

02/06 - Vorbehaltlich Änderungen

Verbreiterungs-Profil
45 x 25

208

11,5

25



Bestellmaß
UK Element

M 1:1

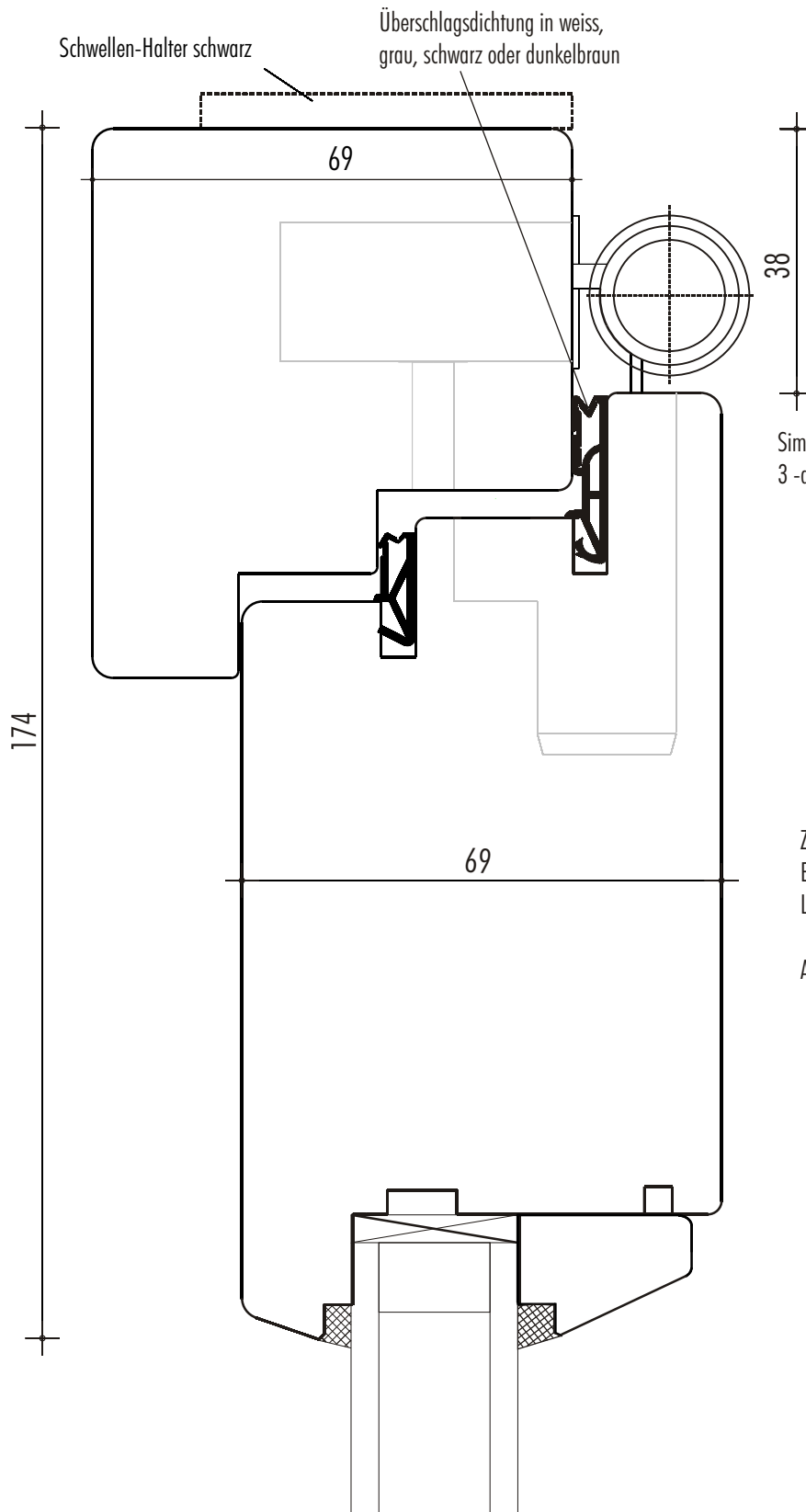
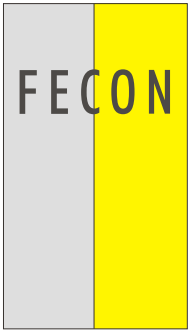
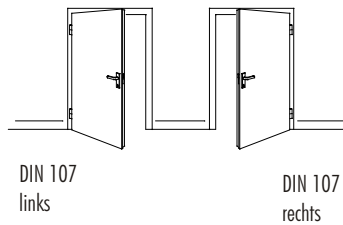

Typ BH

Standard - Haustür
einwärtsschlagend

Bandseite

Simonswerk BAKA 3D-20 protect FD
3-dimensional verstellbar



- mit Stiftsicherung
- Höhen-Verstellung am mittleren Band

Zum Aushängen des Türblattes und Einstellen der Bänder Anleitung beachten!!
Liegt der Tür bei Anlieferung bei

Auf Wunsch:

- Edelstahl - Bänder
- Kappen in RAL - Farben

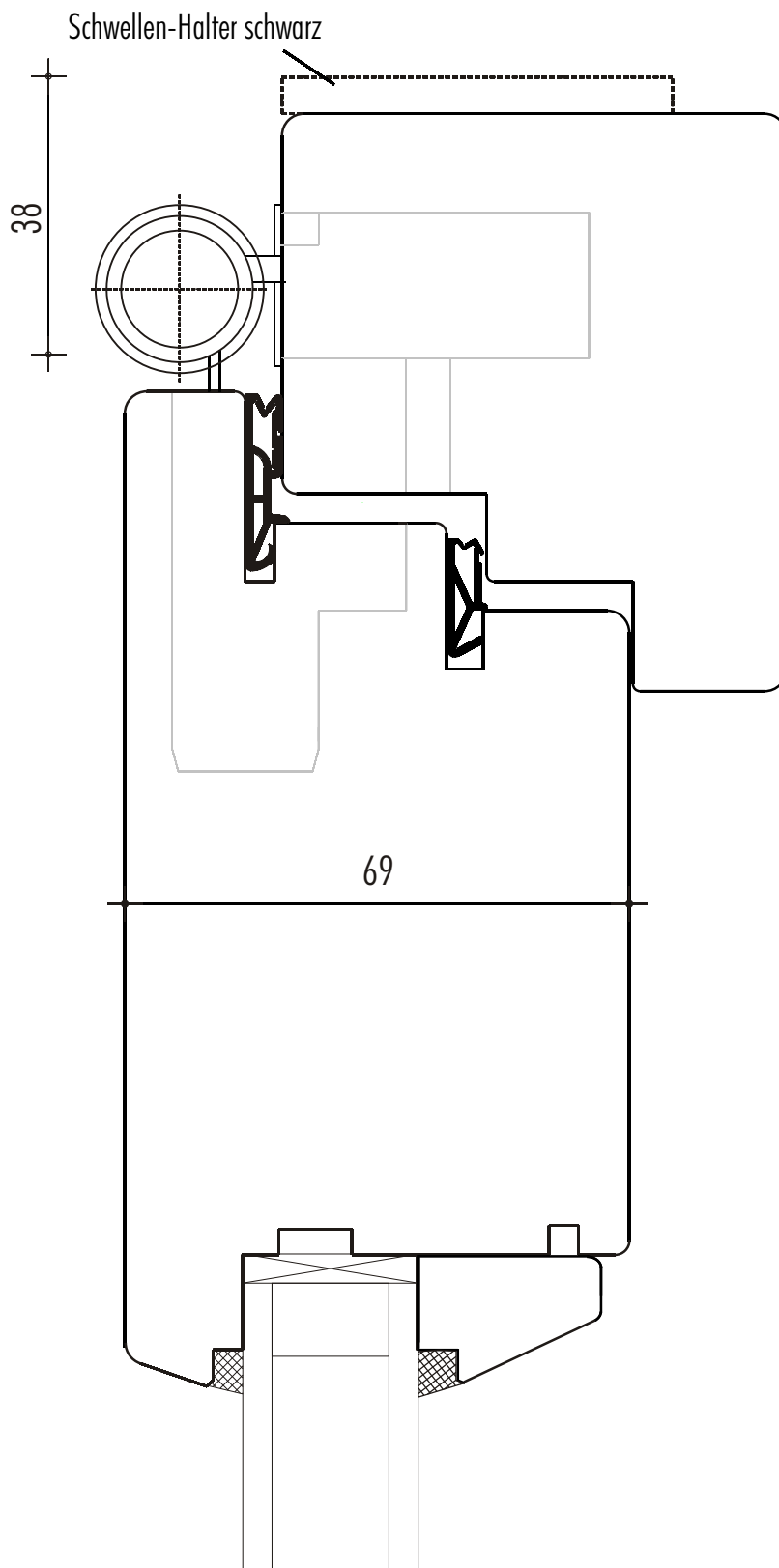

Typ BH

Standard - Haustür
auswärtsschlagend

Bandseite

Bänder:

Simonswerk BAKA 3D-20 protect FD



Standardmässig:

- mit Stiftsicherung
- Höhen-Verstellung am mittleren Band

Auf Wunsch:

- Bänder in Edelstahl
- Kappen in den Farben RAL

DIE FENSTERCONNECTION

69

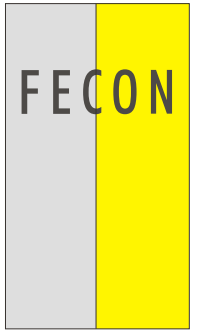
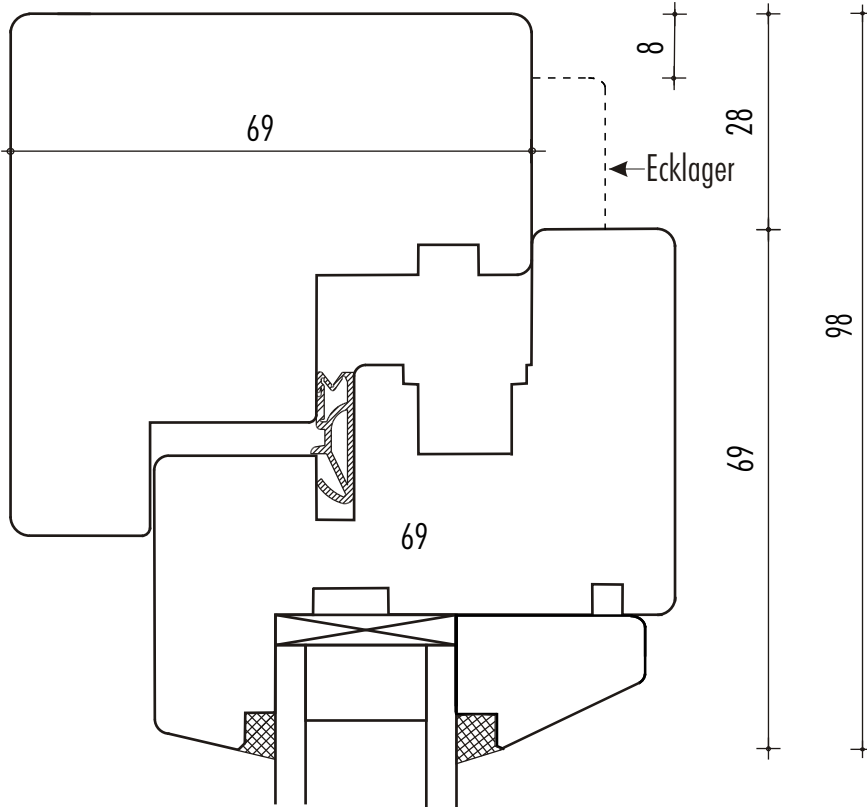

Typ BS und BST

Standard Dreh-Kipp
Fenster

als Vorsatzfenster
Blendrahmen
und Flügel
umlaufend

Mit Roto Royal
könnte der
Blendrahmen
59mm breit sein

69

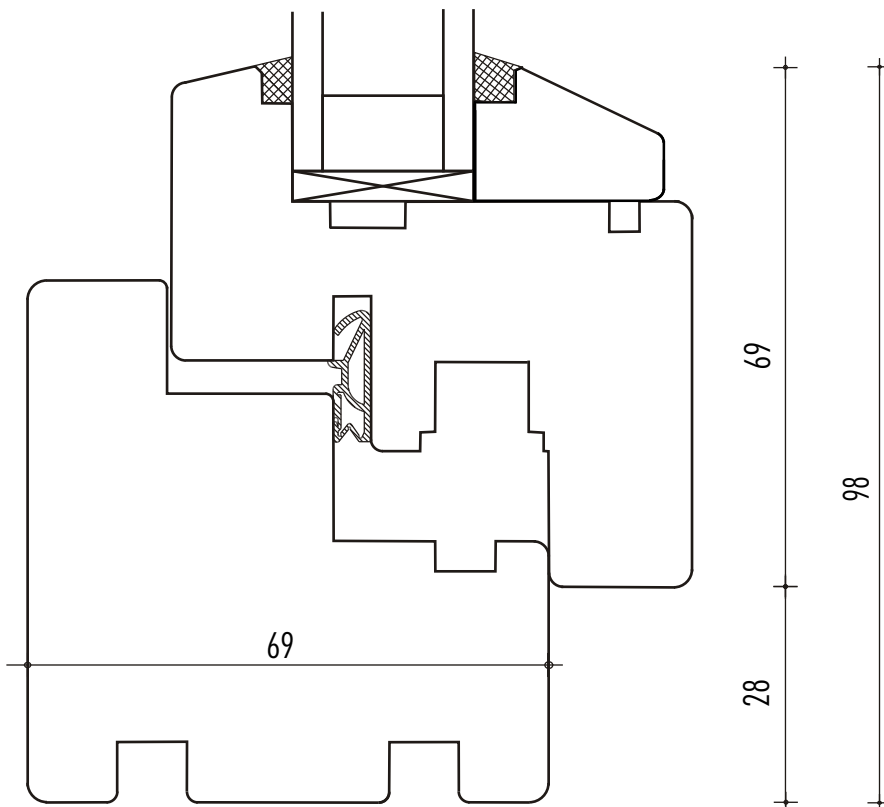

DIE FENSTERCONNECTION

69

50

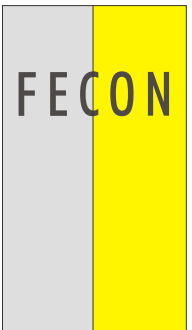
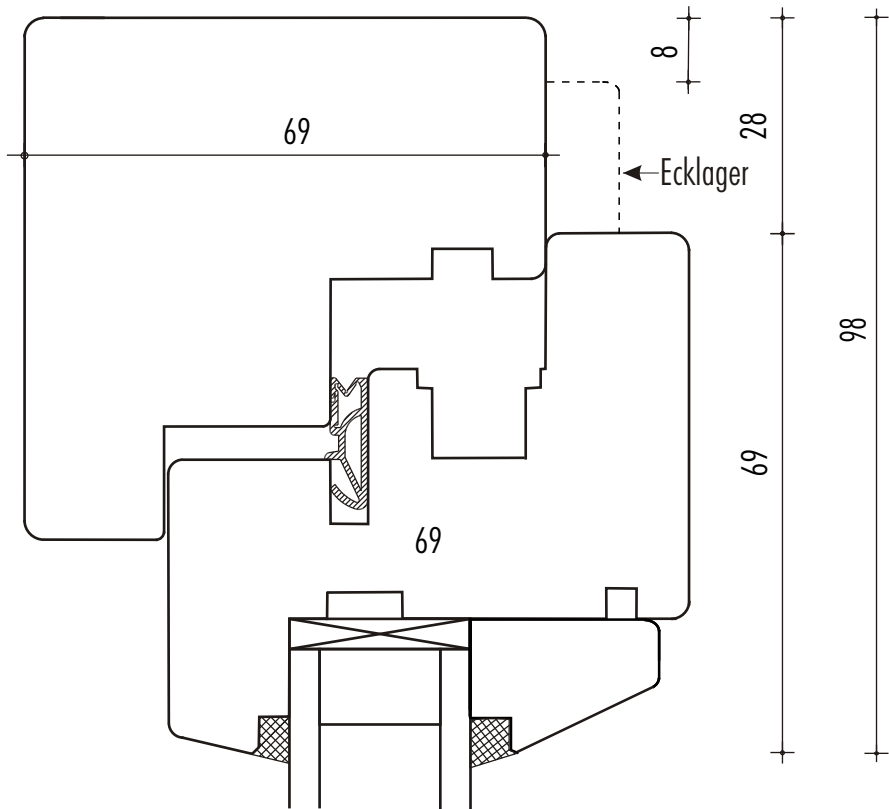

Typ BS und BST

Standard Dreh-Kipp
Fenster und -tür

als Vorsatzfenster
Blendrahmen unten
schmäler

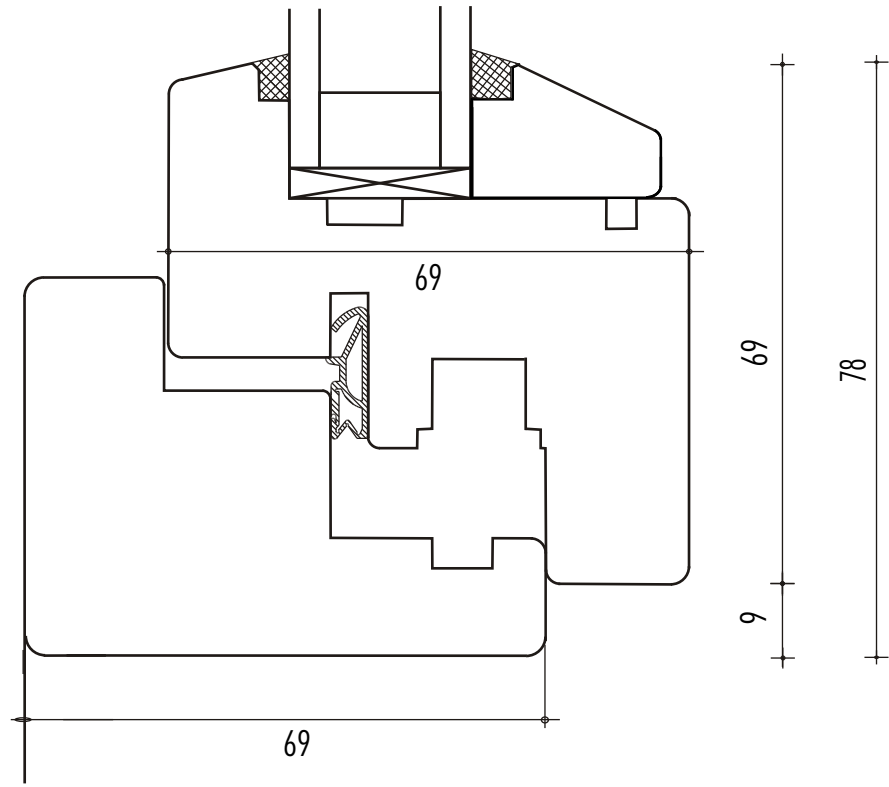

DIE FENSTERCONNECTION

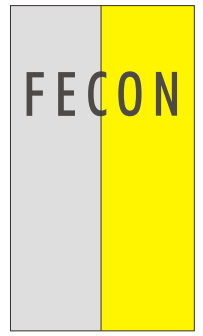
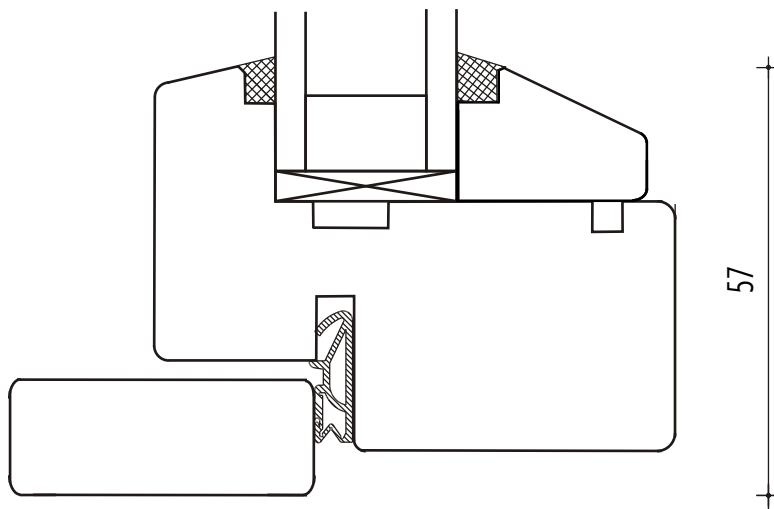
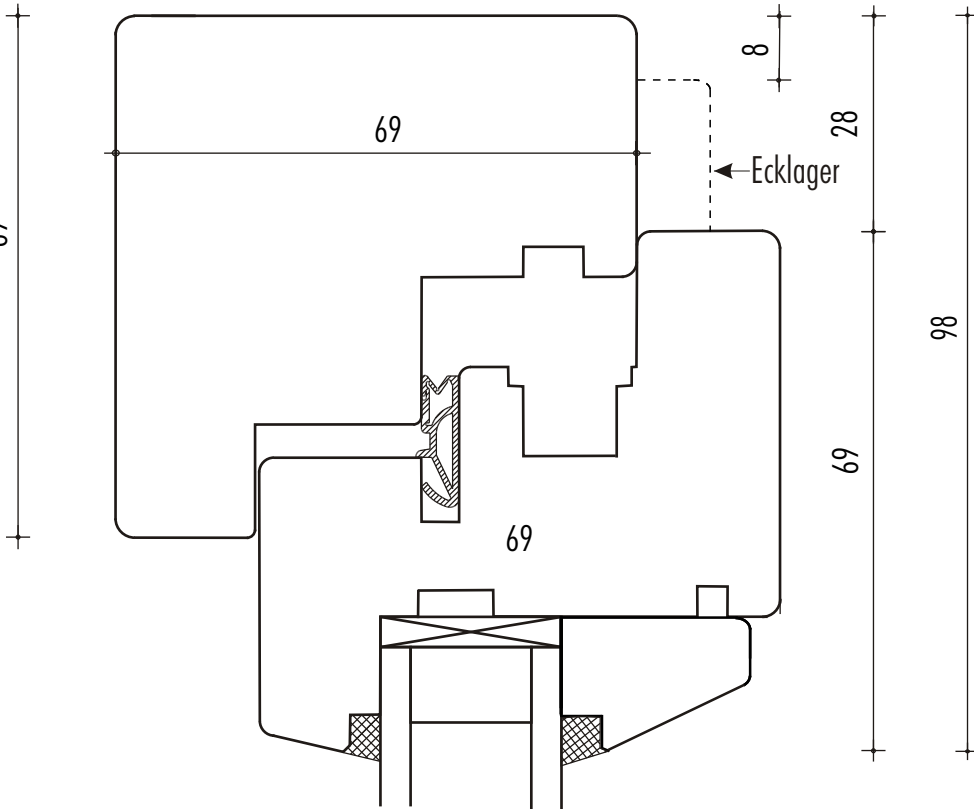

Typ BS und BST

Standard Dreh-Kipp
Fenster und -tür

Als Vorsatzfenster
Flügelrahmen unten
gekürzt

DIE FENSTERCONNECTION

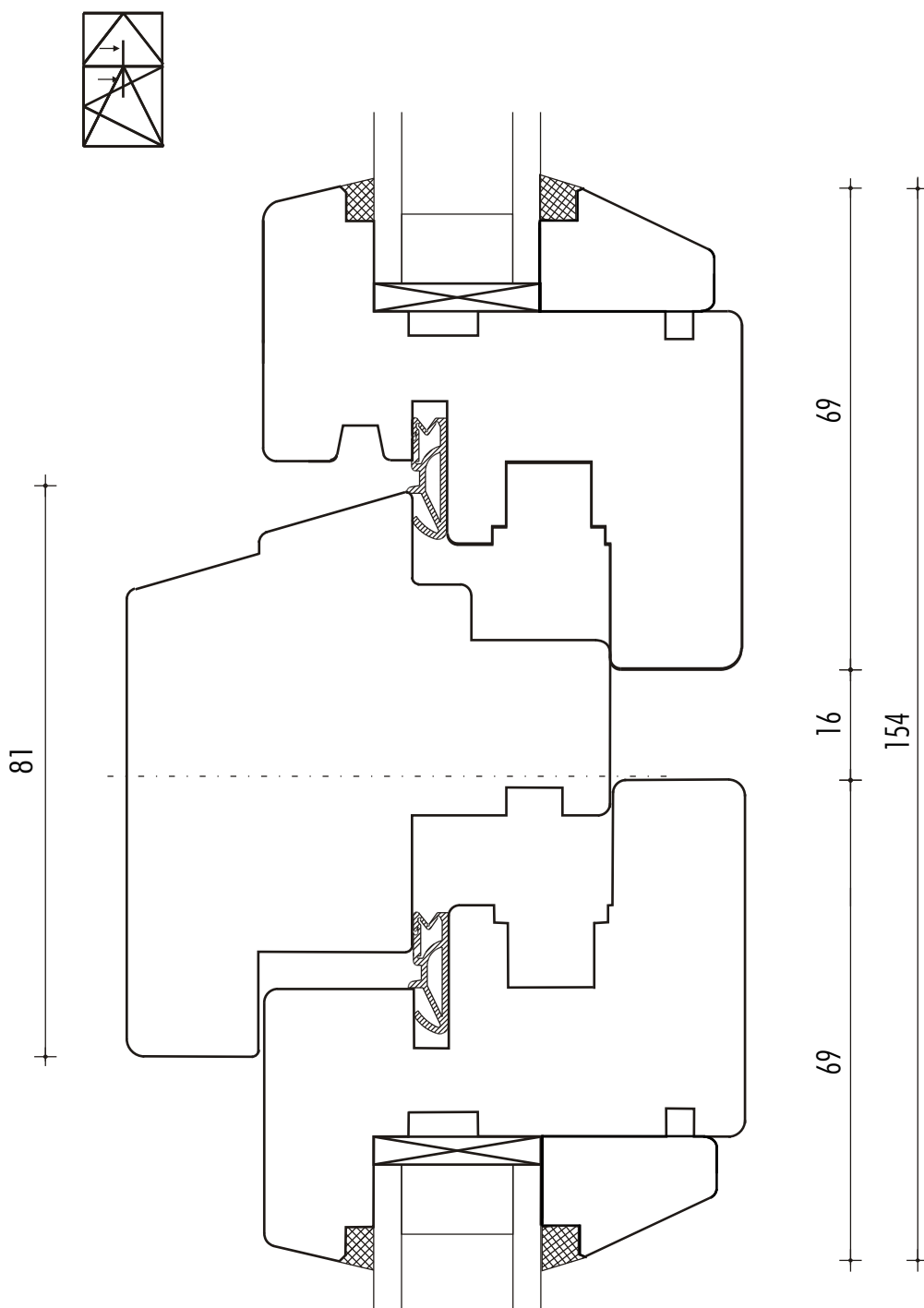

Typ BS

Standard
Dreh-Kipp Fenster
als Vorsatz-Fenster

Kämpfer
und Flügel
schmal, bei
kleinen Flügeln
Kämpfer bis 75mm
Breite möglich