

# Classic - fyrretræ - 3-lags

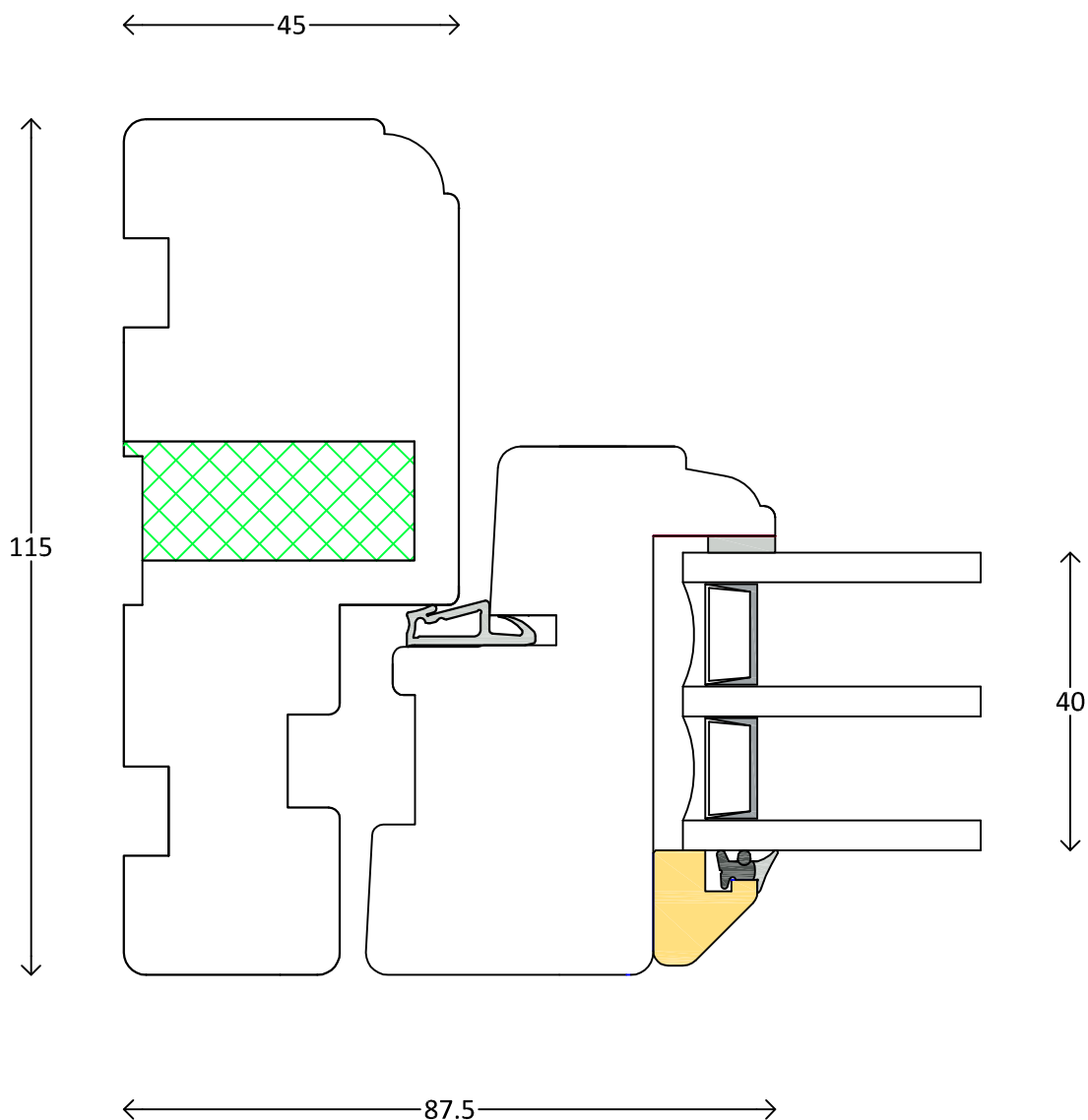

Topstyret/Sidestyret Type 3-7-8  
Sidekarm med ramme  
Topguided/Sideguided Type 3-7-8  
Jamb with sash

Profil : Pynte profil  
Tegning : HJSc-63  
Oprettet : 12-10-11  
Rev.nr. : 03

# Classic - fyrretræ - 3-lags

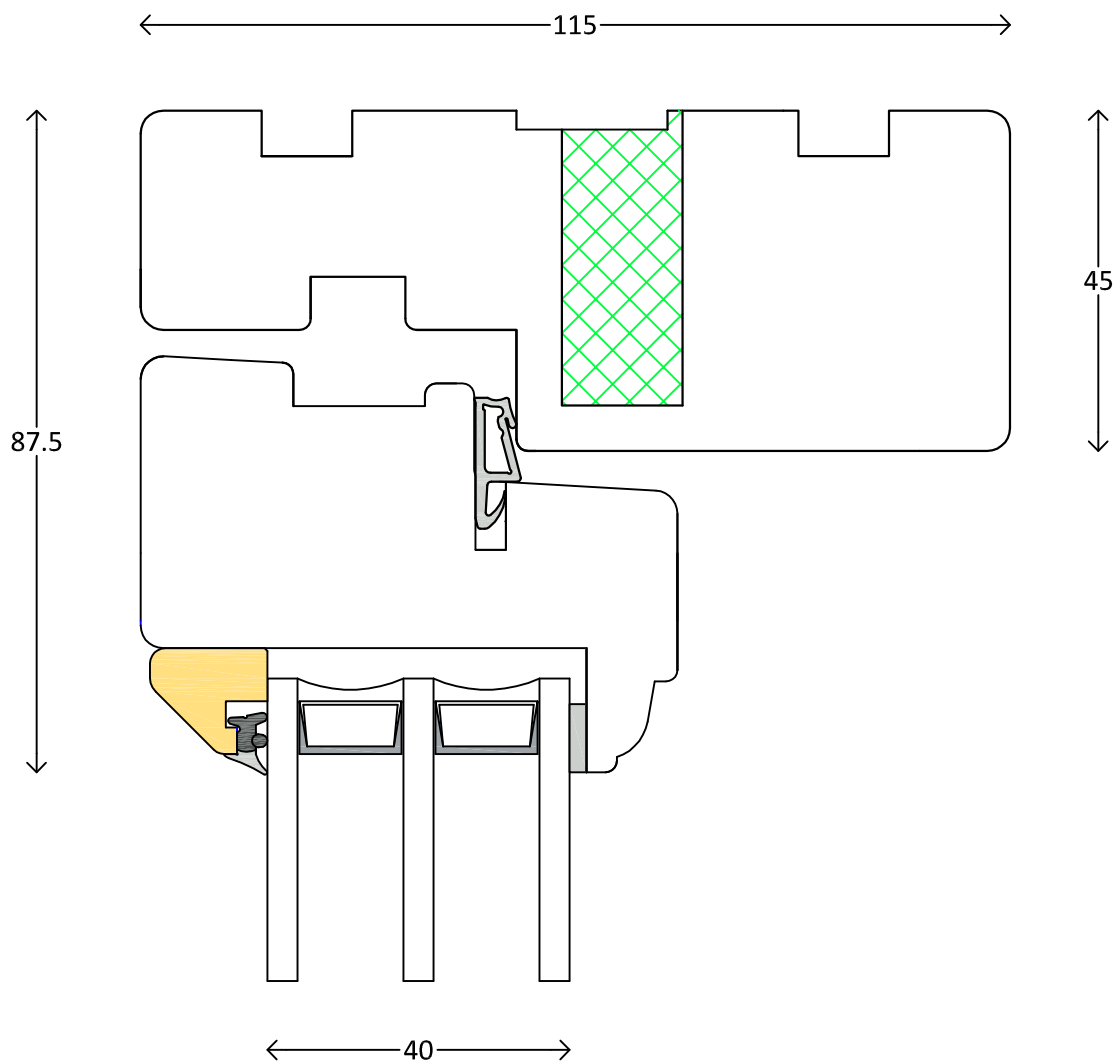

Topstyret/Sidestyret Type 3-7-8  
Overkarm med ramme  
Topguided/Sideguided Type 3-7-8  
Head with sash

Profil : Pynte profil  
Tegning : HJSc-61  
Oprettet : 12-10-11  
Rev.nr. : 03

# Classic - fyrretræ - 3-lags

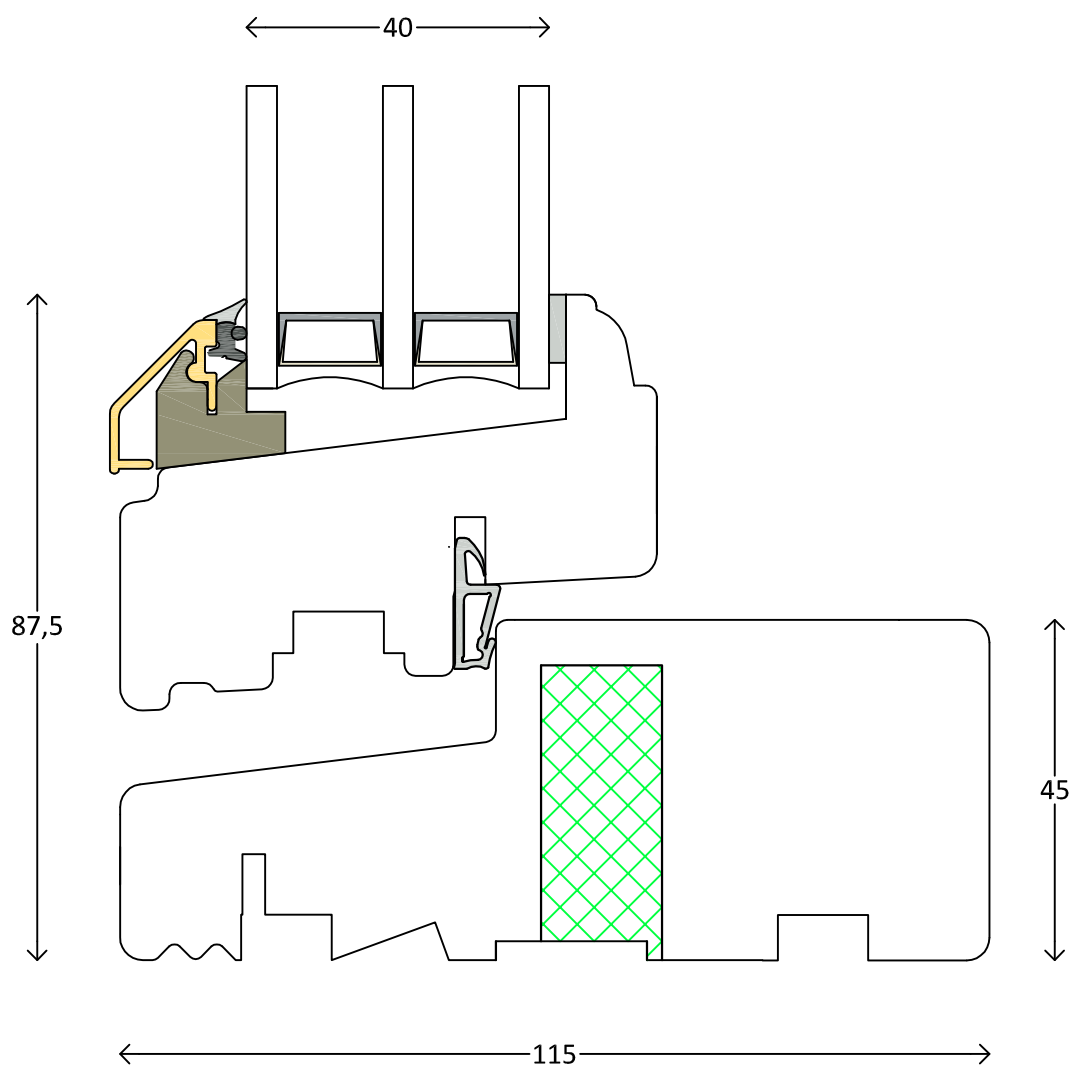

Topturn/Topstyret/Sidestyret Type 2-3-7-8  
Bundkarm med ramme  
Top Turn/Topguided/Sideguided Type 2-3-7-8  
Sill with sash

Profil : Pynte profil  
Tegning : HJSc-62  
Oprettet : 12-10-11  
Rev.nr. : 03

## Typ OFT

Die Dänische Fenstertür auswärtsschlagend

FECON

### Standard

Türschwelle aus Hartholz und Flügelrahmen unten  
(seitlich und oben wie Typ OF)

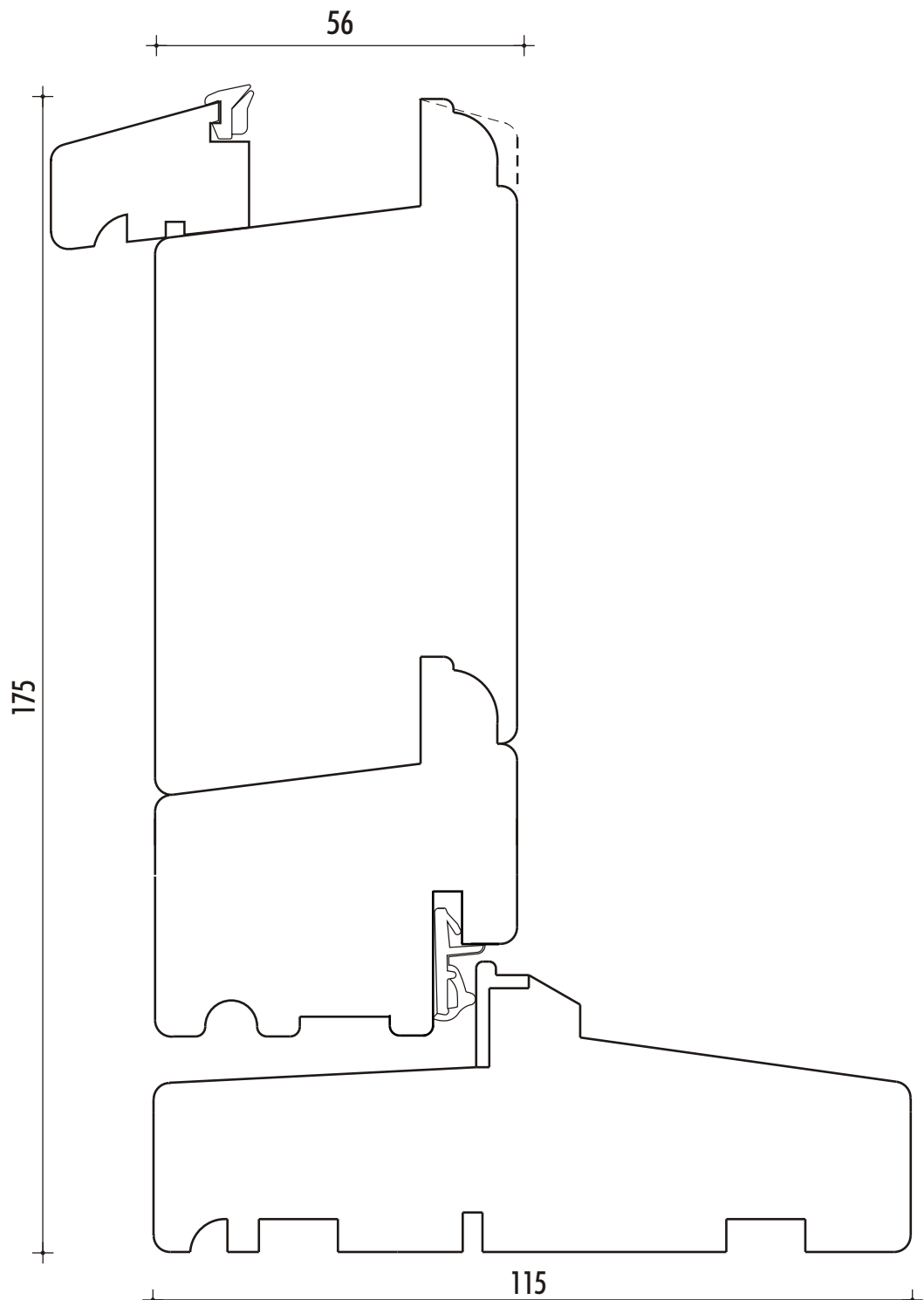



# Classic - fyrretræ - 3-lags

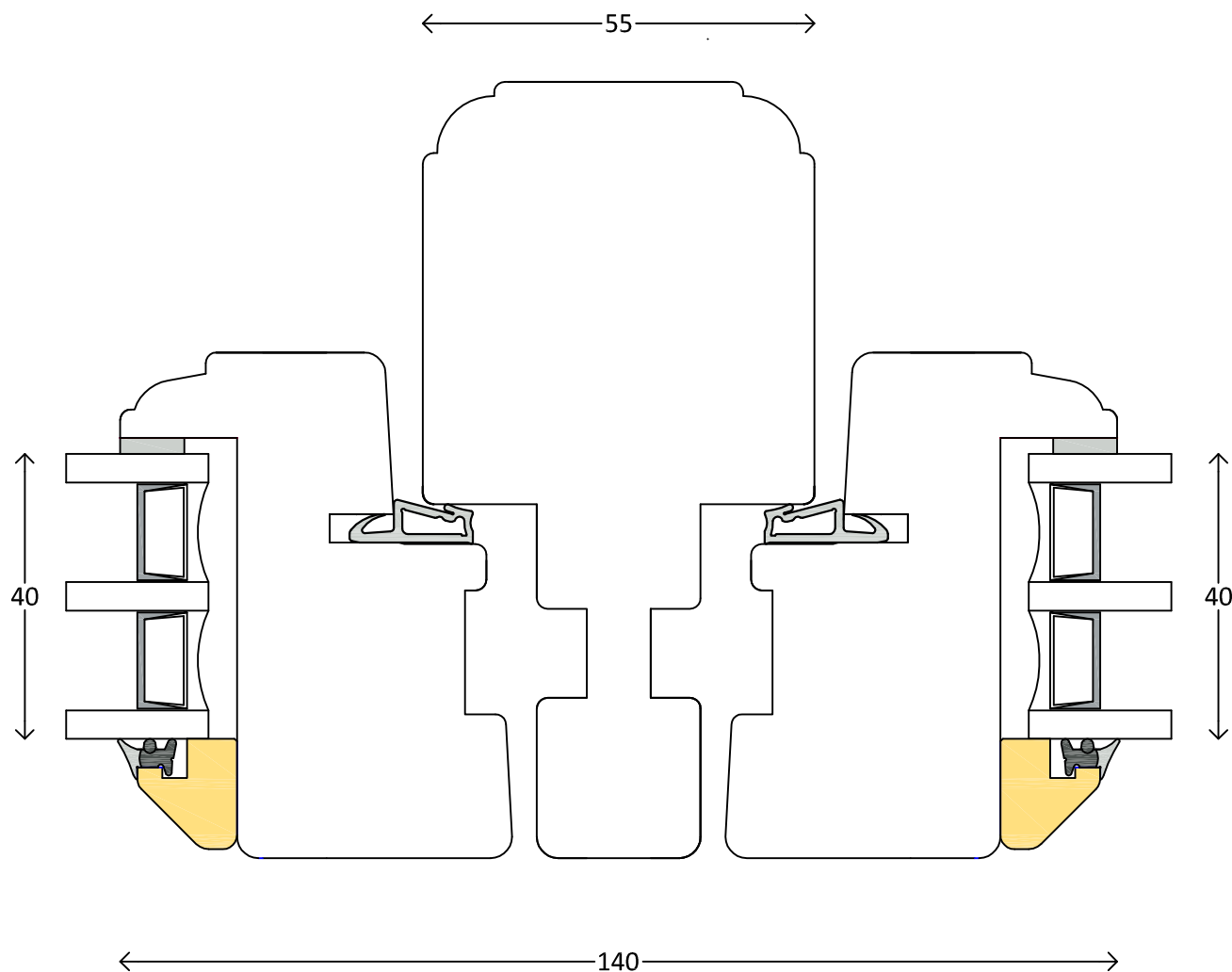

Topstyret/Sidehængt Type 3-7-8  
Lodpost med rammer  
Top Guided/Side hung Type 3-7-8  
Mullion with sashes

Profil : Pynte profil  
Tegning : HJSc-66  
Oprettet : 06-06-11  
Rev.nr. : 01

# Classic - fyrretræ

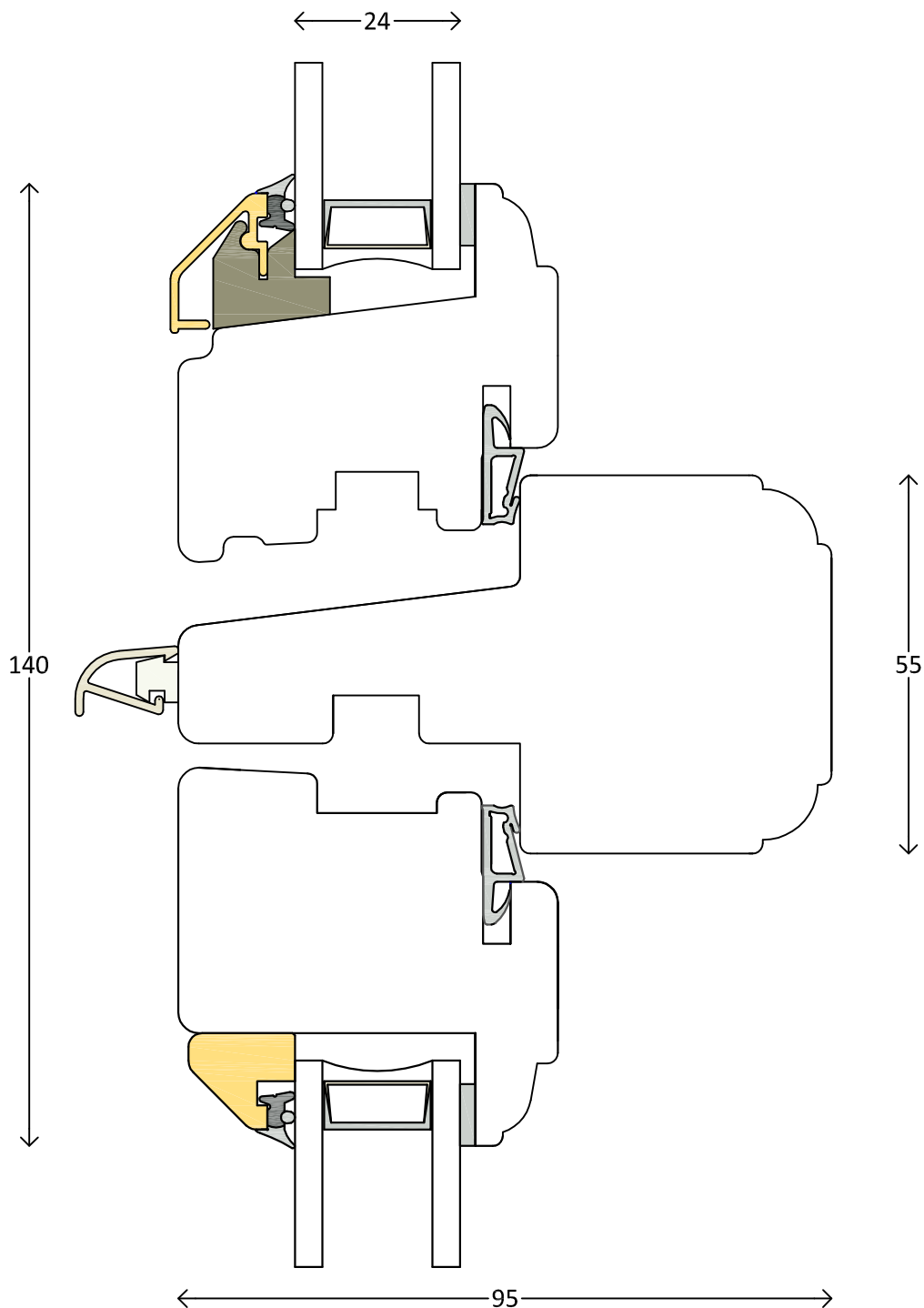

Sidehængt Type 8  
Vandret post med rammer  
Side Hung Type 8  
Transom with sashes

Profil : Pynte profil  
Tegning : HJSc-07  
Oprettet : 06-06-11  
Rev.nr. : 01



# Classic - fyrretræ - 3-lags

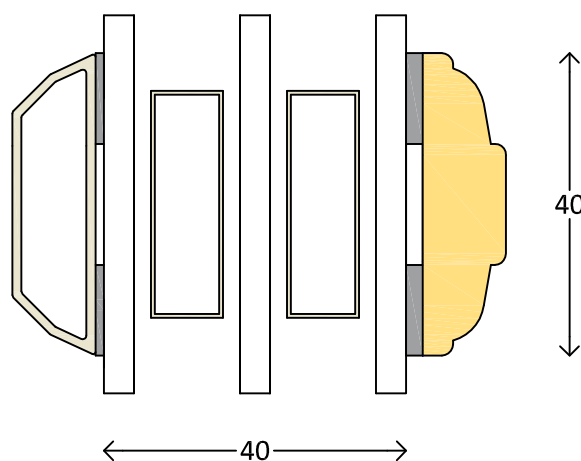
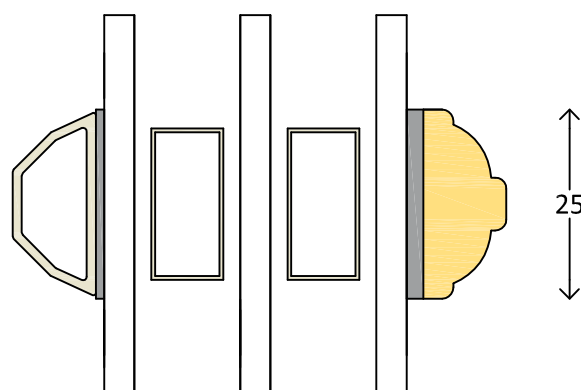
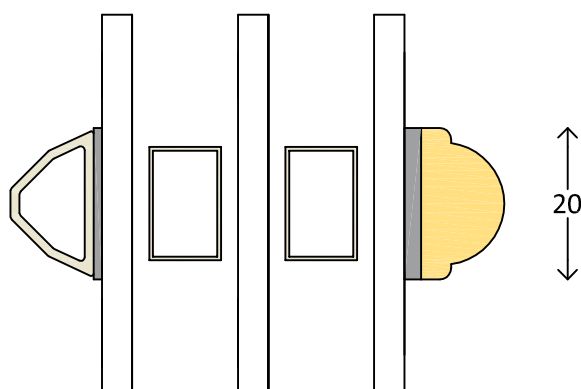

Energi sprosse Type 20-25-40. Oplukkelig ramme

Lodret snit

Styling Bar Type 20-25-40

Vertical section

Profil : Pynte profil

Tegning : HJSc-78

Oprettet : 28-10-11

Rev.nr. : 01

## Typ OF

Das Dänische Fenster auswärtsschlagend

FECON

### Sprossen

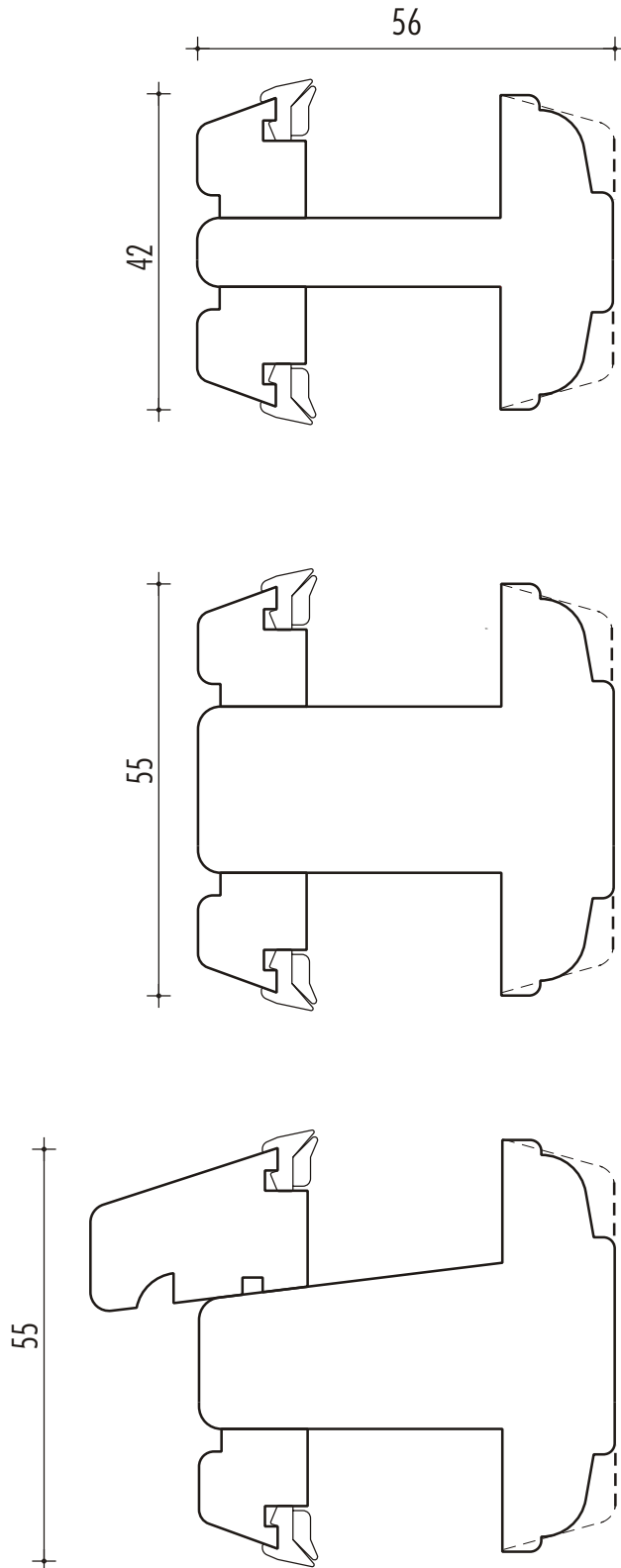

Standard  
mit Trockenverglasung

Auf Wunsch innen und außen  
versiegelt,  
Glasleisten verdeckt gestiftet



# Classic - fyrretræ - 3-lags

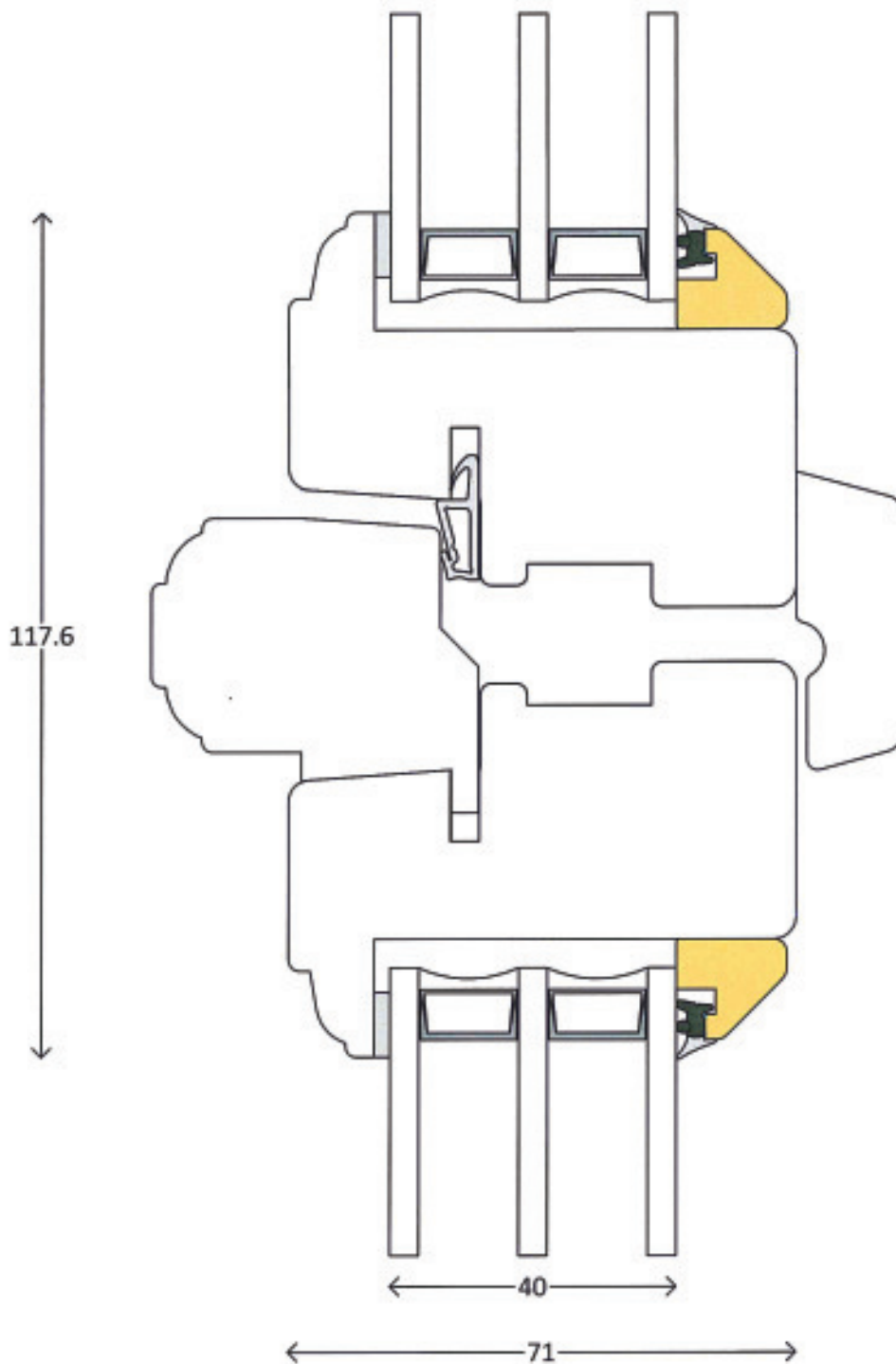

Harmonidør  
Sammenlukkkelige rammer

Profil : Pynte profil  
Tegning :  
Oprettet : 18-04-12  
Rev.nr. : 00

# Classic - fyrretræ - 3-lags

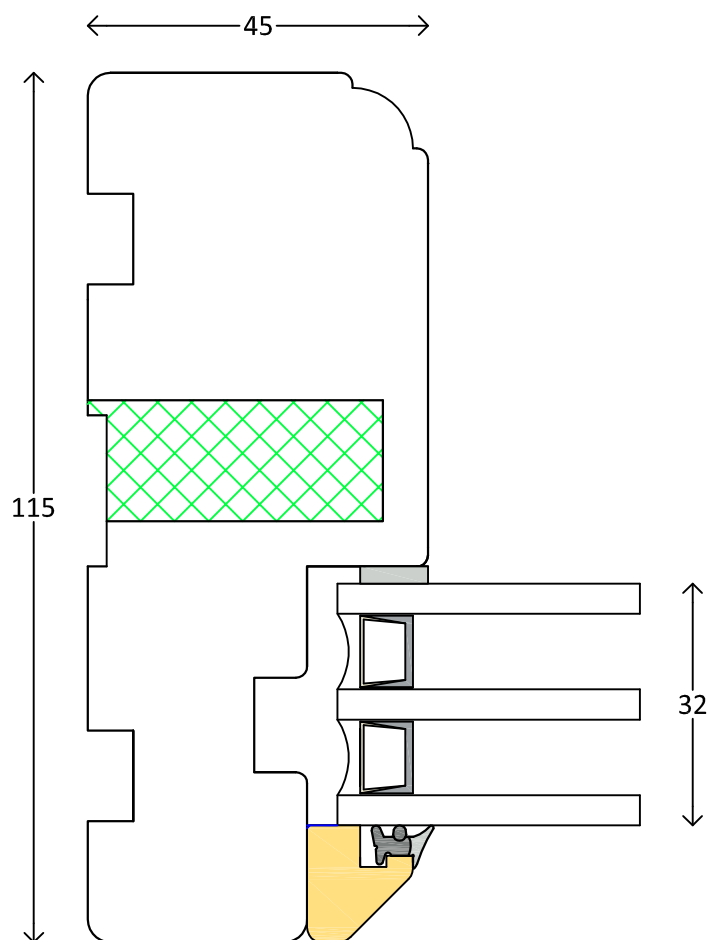

Fast karm/Vindueselement Type 5-6  
Sidekarm  
Fixed Light/Sprandrel Unit Type 5-6  
Jamb

Profil : Pynte profil  
Tegning : HJSc-83  
Oprettet : 12-10-11  
Rev.nr. : 03

# Classic - fyrretræ - 3-lags

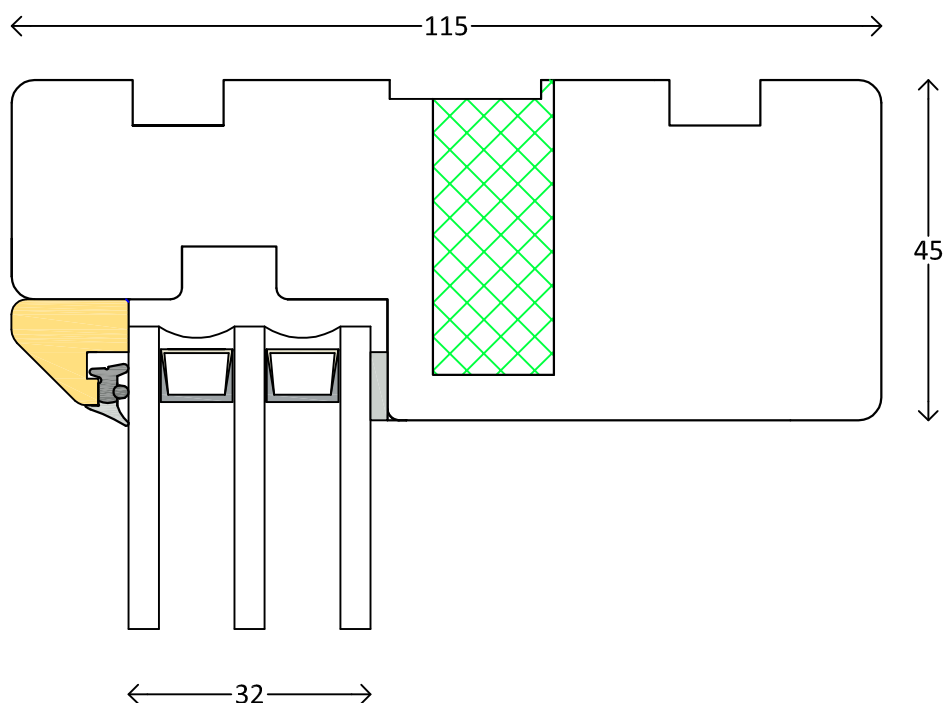

Fast karm/Vindueselement Type 5-6  
Overkarm  
Fixed Light/Sprandrel Unit Type 5-6  
Head Frame

Profil : Pynte profil  
Tegning : HJSc-81  
Oprettet : 12-10-11  
Rev.nr. : 03

# Classic - fyrretræ - 3-lags

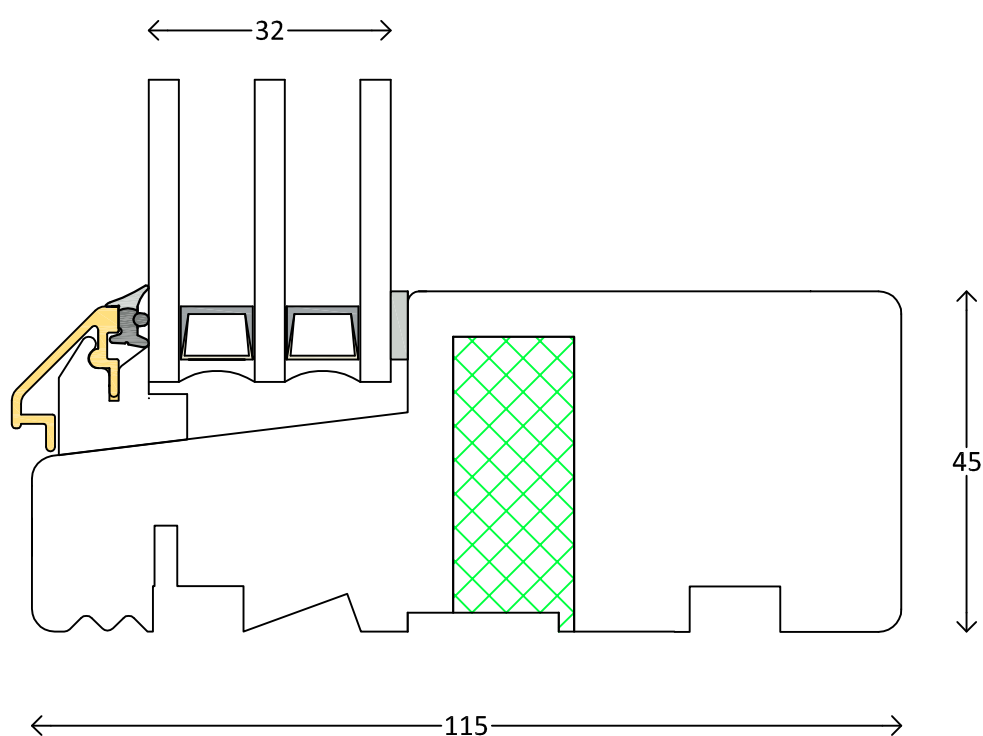

Fast karm/Vindueselement Type 5-6  
Bundkarm  
Fixed Light/Sprandrel Unit Type 5-6  
Sill

Profil : Pynte profil  
Tegning : HJSc-82  
Oprettet : 12-10-11  
Rev.nr. : 03



# Classic - fyrretræ - 3-lags

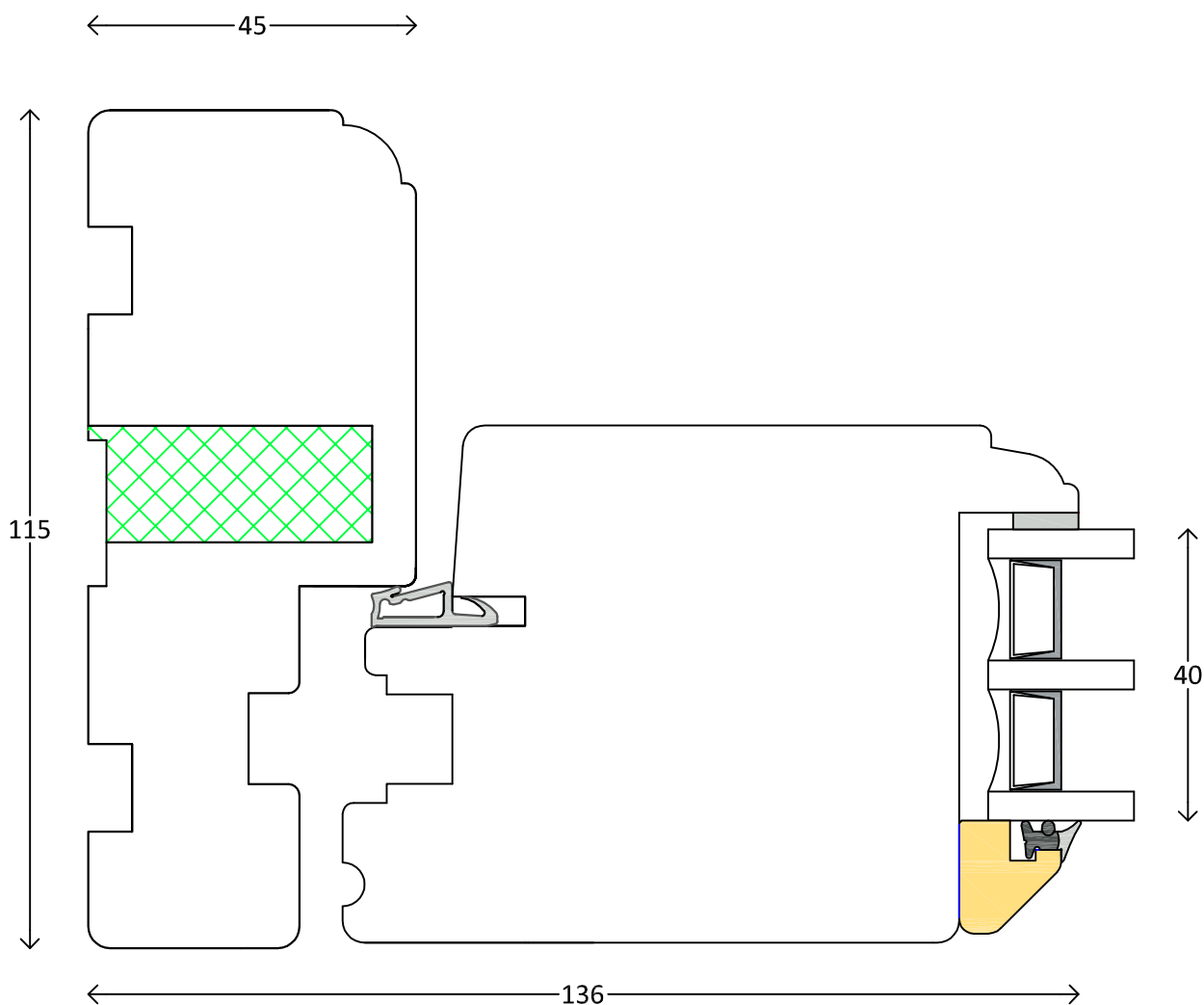

Terrassedør, udadgående Type 9-11-14  
Sidekarm med ramme

Profil : Pynte profil  
Tegning : HJSc-354  
Oprettet : 12-10-11  
Rev.nr. : 03

# Classic - fyrretræ - 3-lags

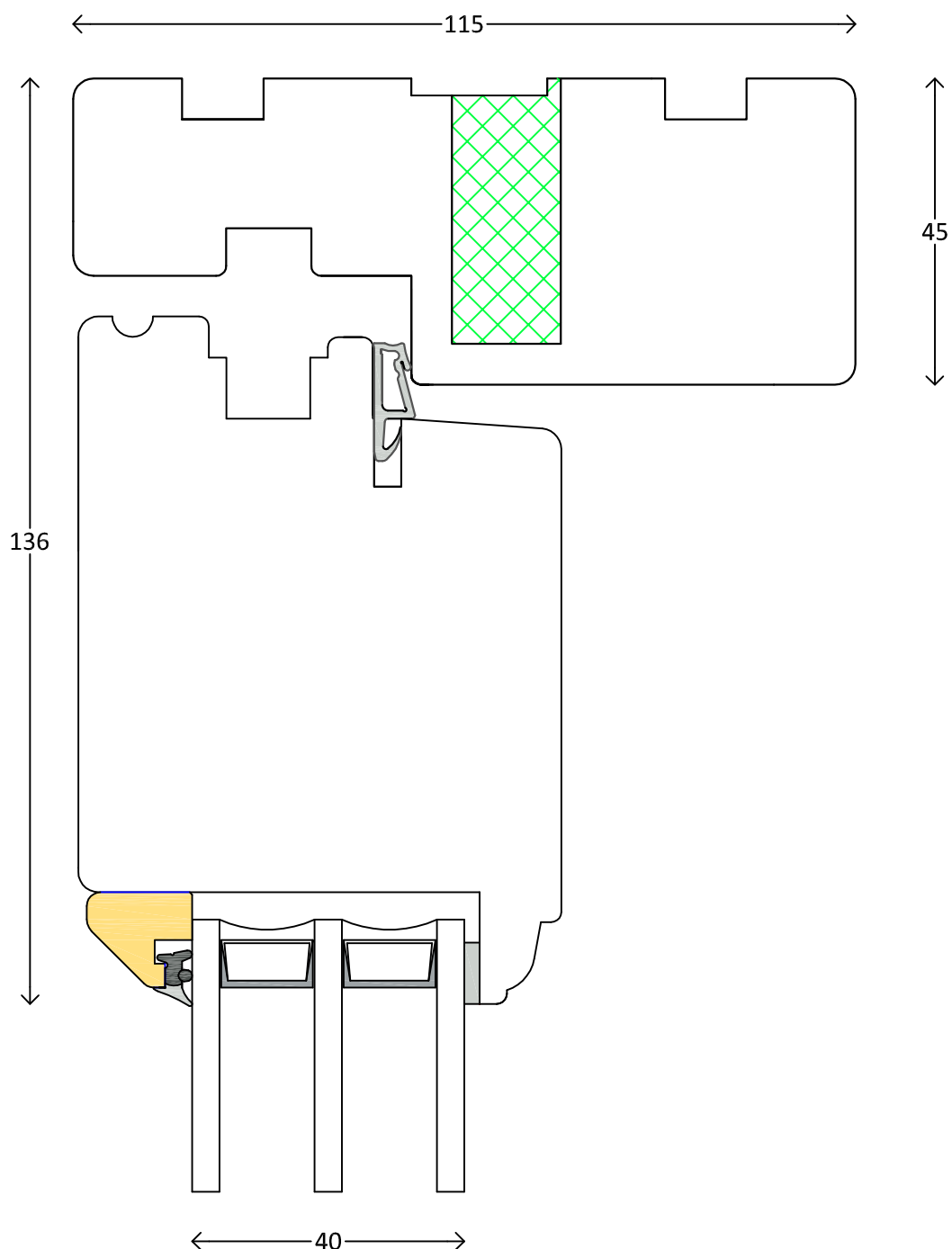

Terrassedør, udadgående Type 9-11-14  
Overkarm med ramme

Profil : Pynte profil  
Tegning : HJSc-351  
Oprettet : 12-10-11  
Rev.nr. : 03



**Outrup**  
VINDUER & DØRE

## Classic - fyrretræ - 3-lags

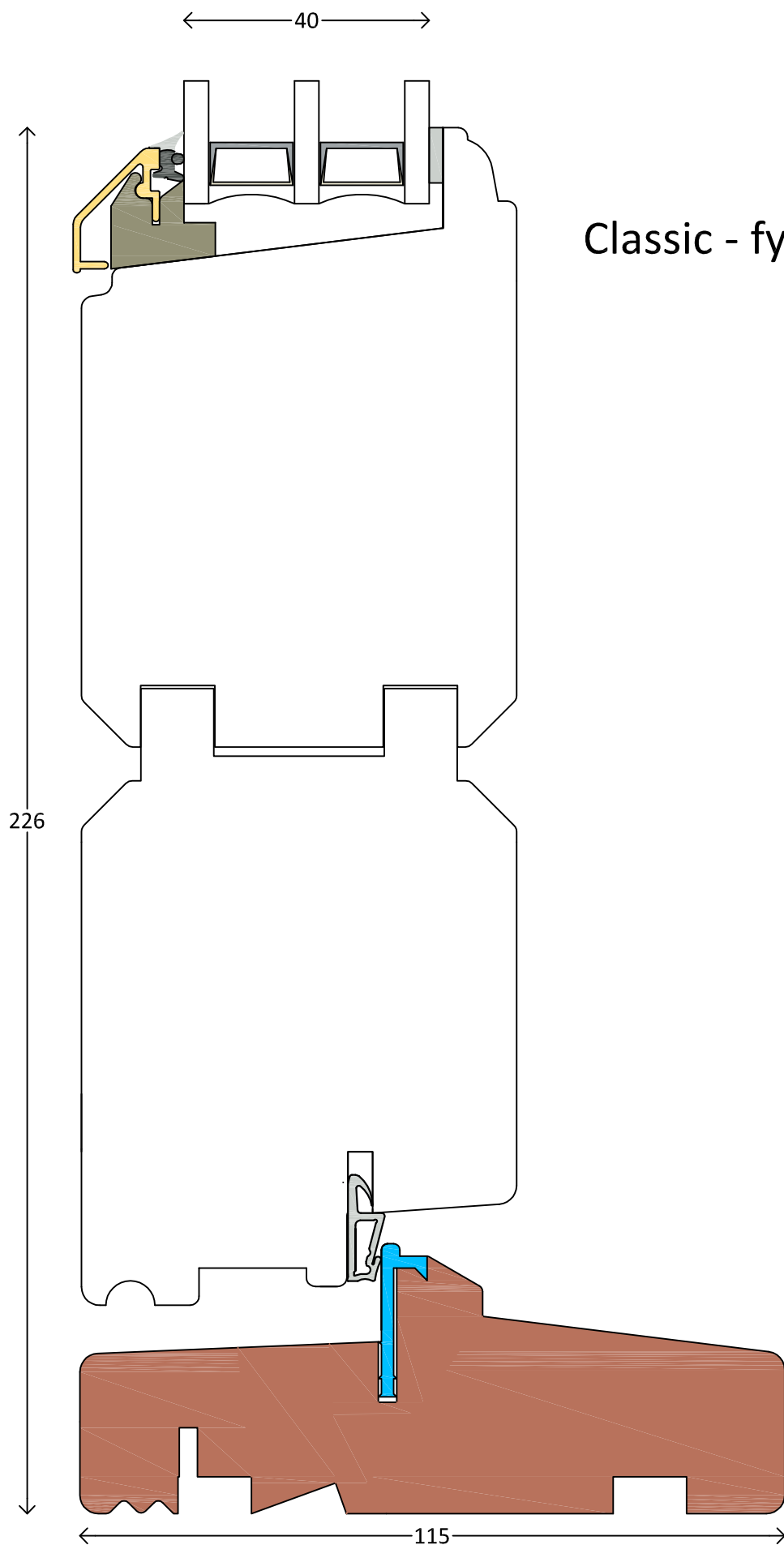

Terrassedør, udadgående Type 9-11-14  
Bundkarm - hårdtræ

Profil : Pynte profil  
Tegning : HJSc-352  
Oprettet : 06-06-11  
Rev.nr. : 01



Outrup  
VINDUER & DØRE

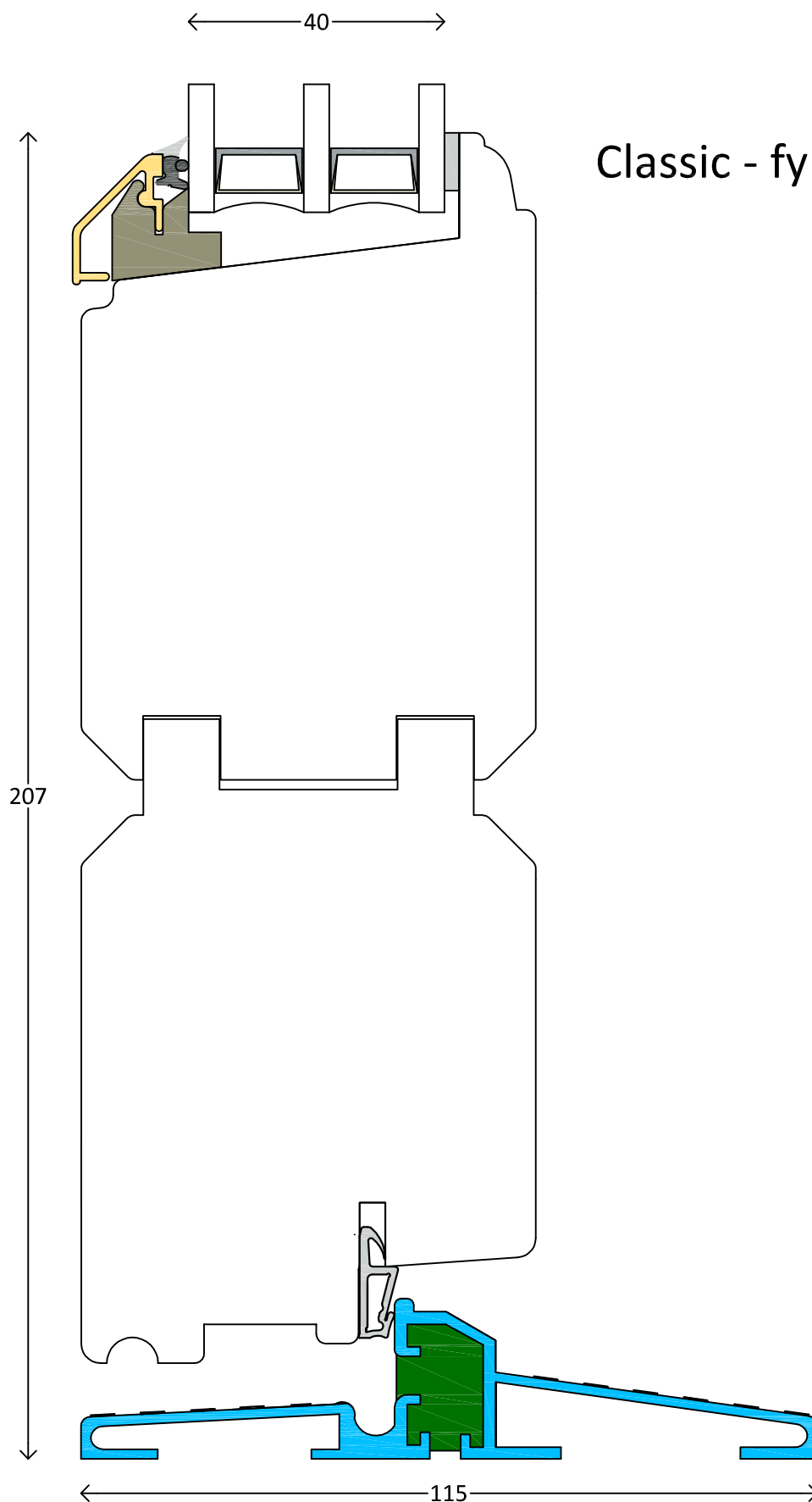

## Classic - fyrretræ - 3-lags

Terrassedør, udadgående Type 9-11-14  
Bundkarm - Aluminium

Profil : Pynte profil  
Tegning : HJSc-353  
Oprettet : 06-06-11  
Rev.nr. : 01



# Typ OHI, OTI

Die Dänische Haustür u. Terrassentür einwärtsschlagend

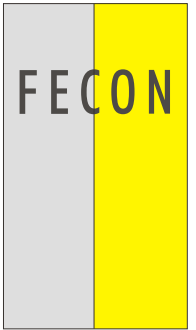

## Standard

Türschwelle aus Hartholz

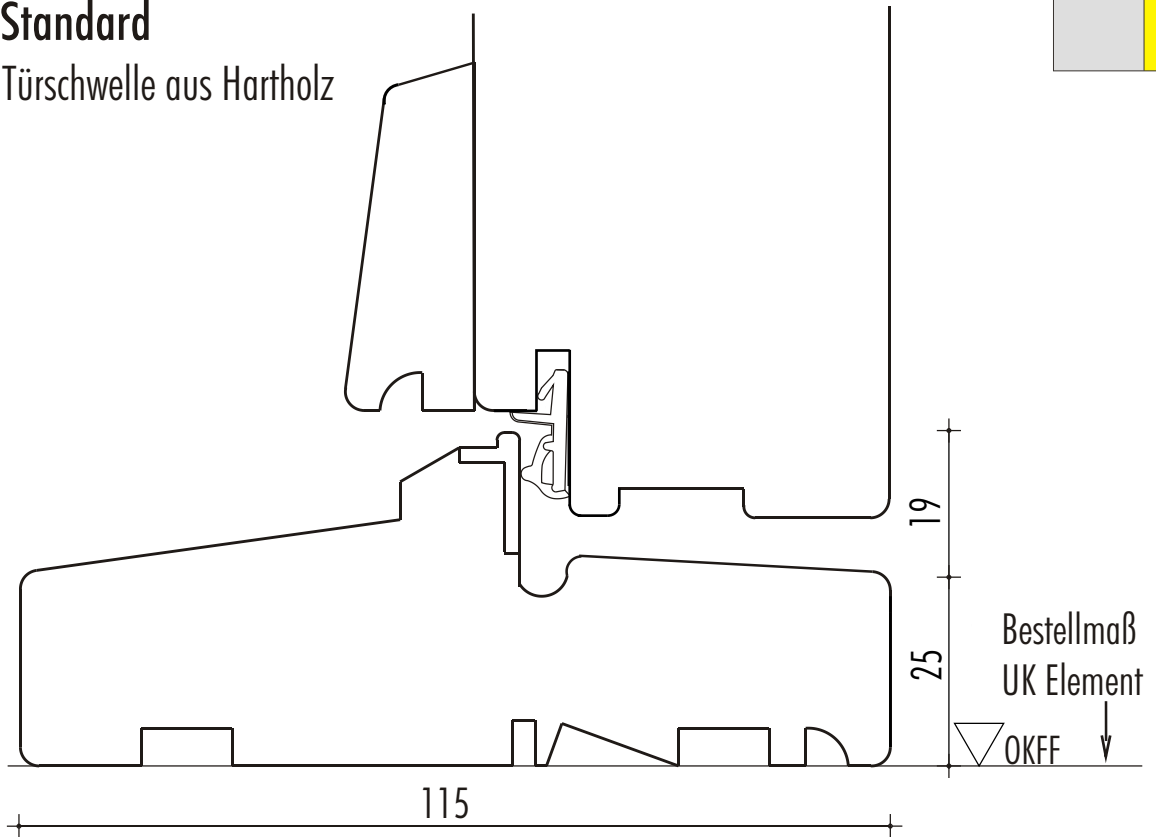

## Auf Wunsch

Türschwelle aus Alu

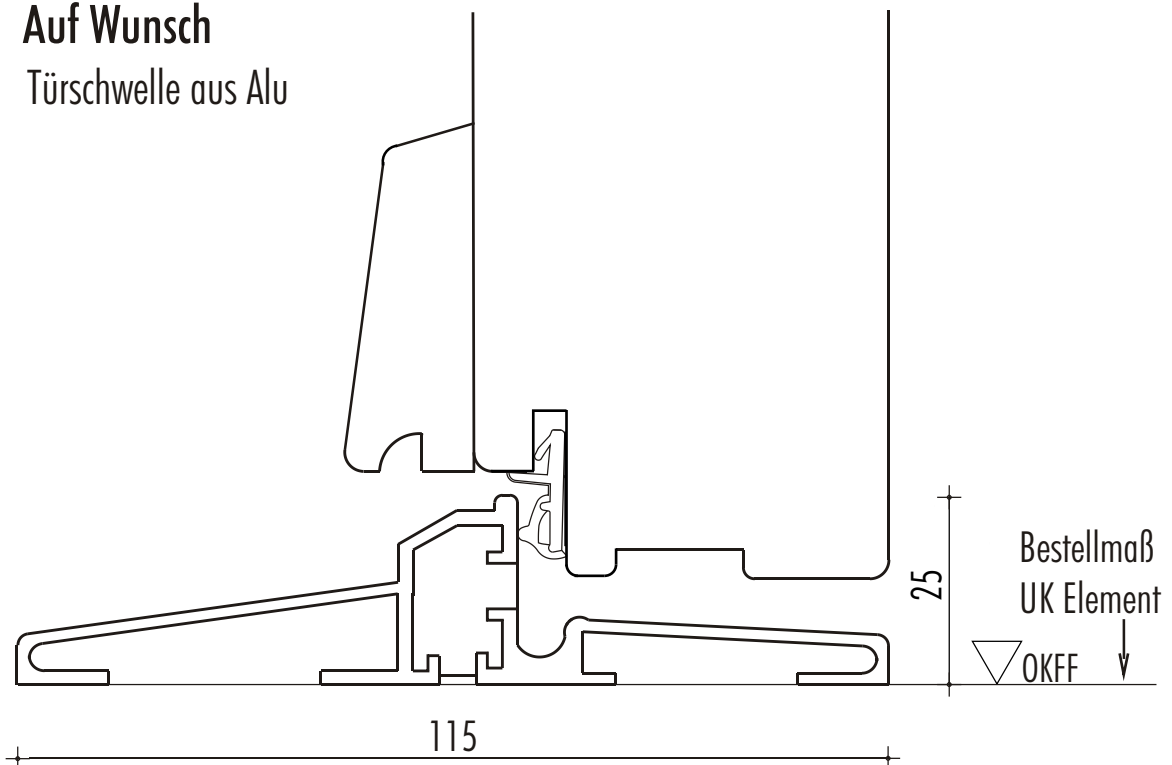

## Classic - fyrretræ

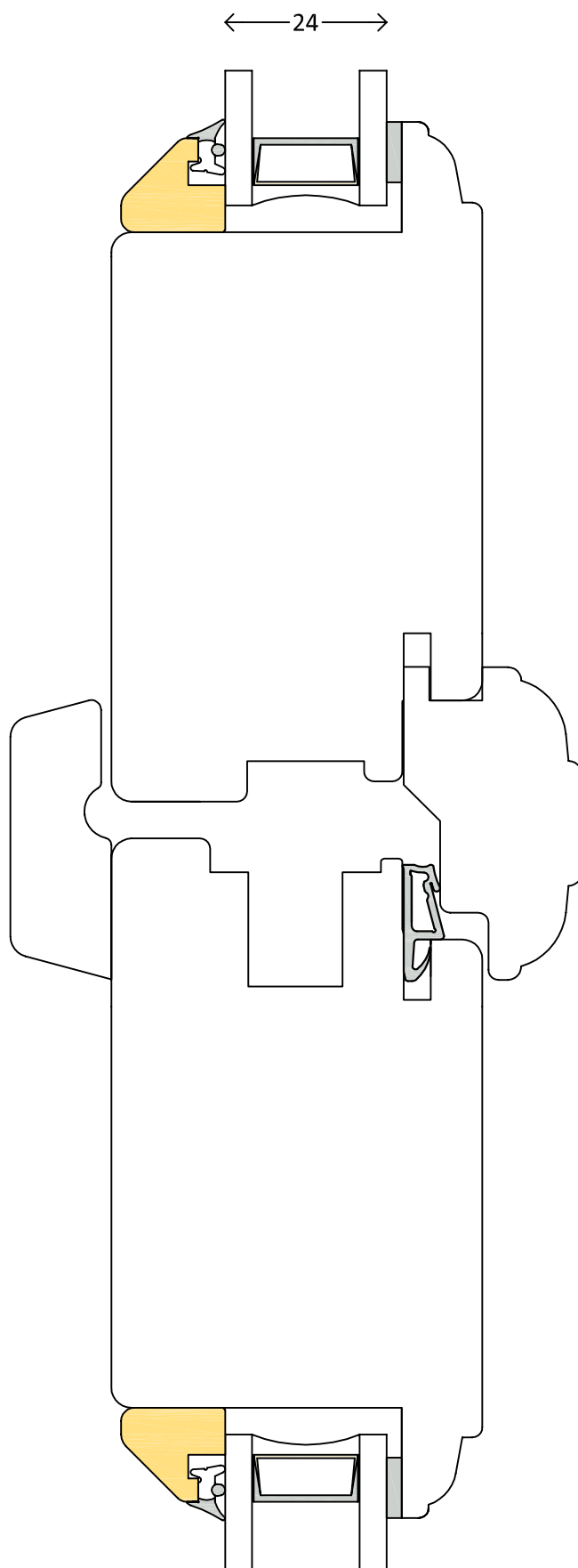

Terrassedør, udadgående Type 9-11-14  
Sammenlukkelige rammer

Profil : Pynte profil  
Tegning : HJSc-310  
Oprettet : 06-06-11  
Rev.nr. : 01

# Classic - fyrretræ - 3-lags

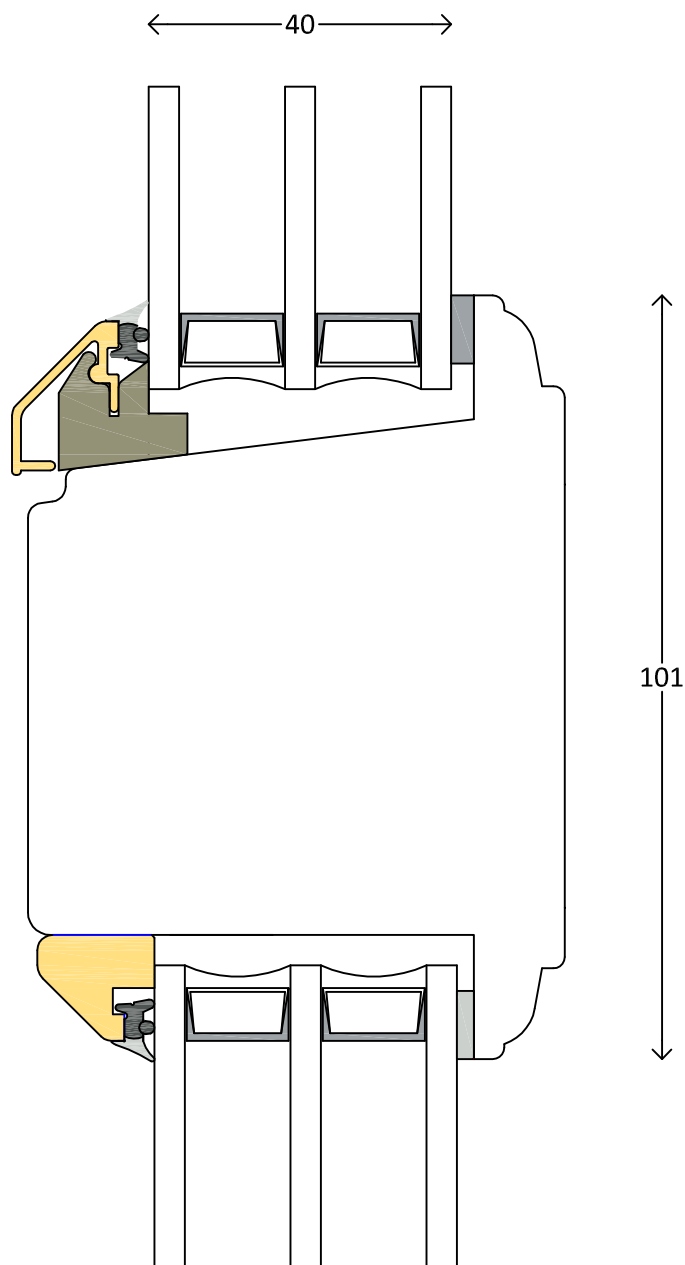

Terrassedør, udadgående Type 9-11-14  
Vandret tapstykke

Profil : Pynte profil  
Tegning : HJSc-365  
Oprettet : 06-06-11  
Rev.nr. : 01

# Typ OKA

Die Dänische Klöntür

Mittelteil - Stulp

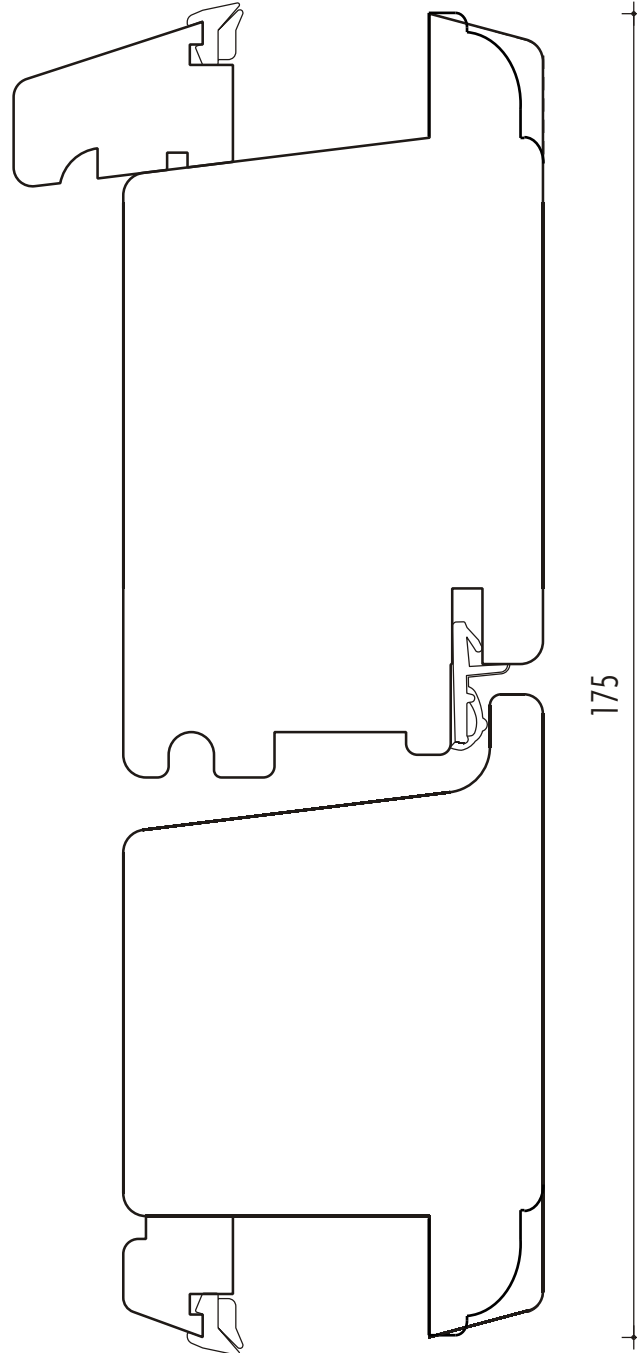
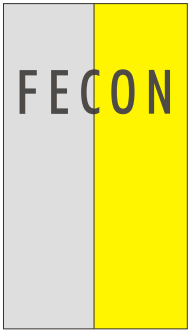

# Typ OHA u. OHI

Auf Wunsch dänisches  
Schloss für deutsche  
Wohnungs-Eingangsrücker

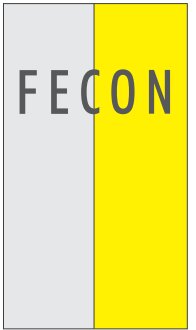

## Profilzylinder - Masse

mit 3-fach-Glas

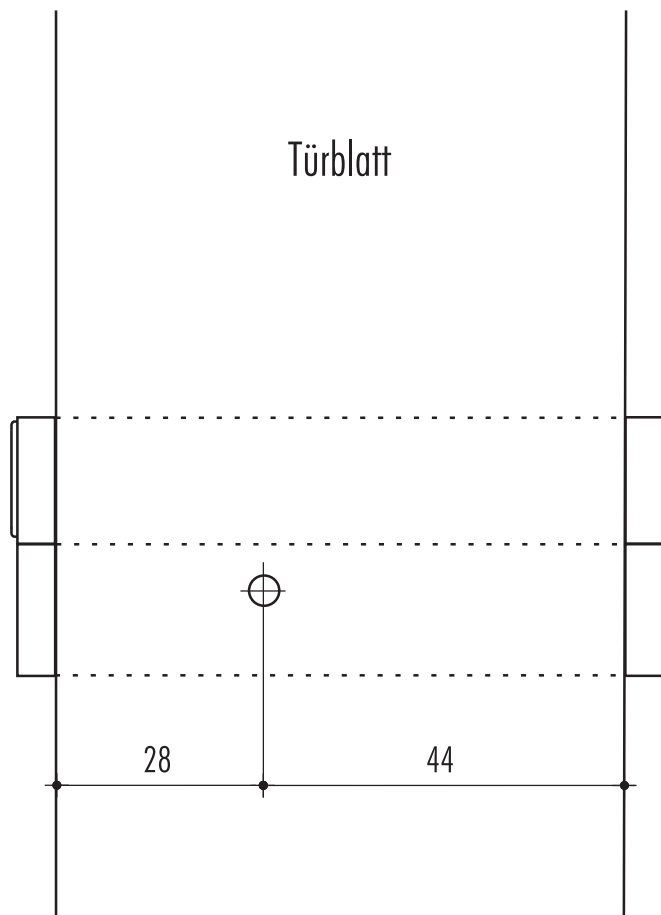

Innenseite

Schildstärken  
zurechnen!

## Typ OHA u. OHI

Auf Wunsch dänisches  
Schlosse für dtsche.  
Wohnungs-Eingangsdrücker

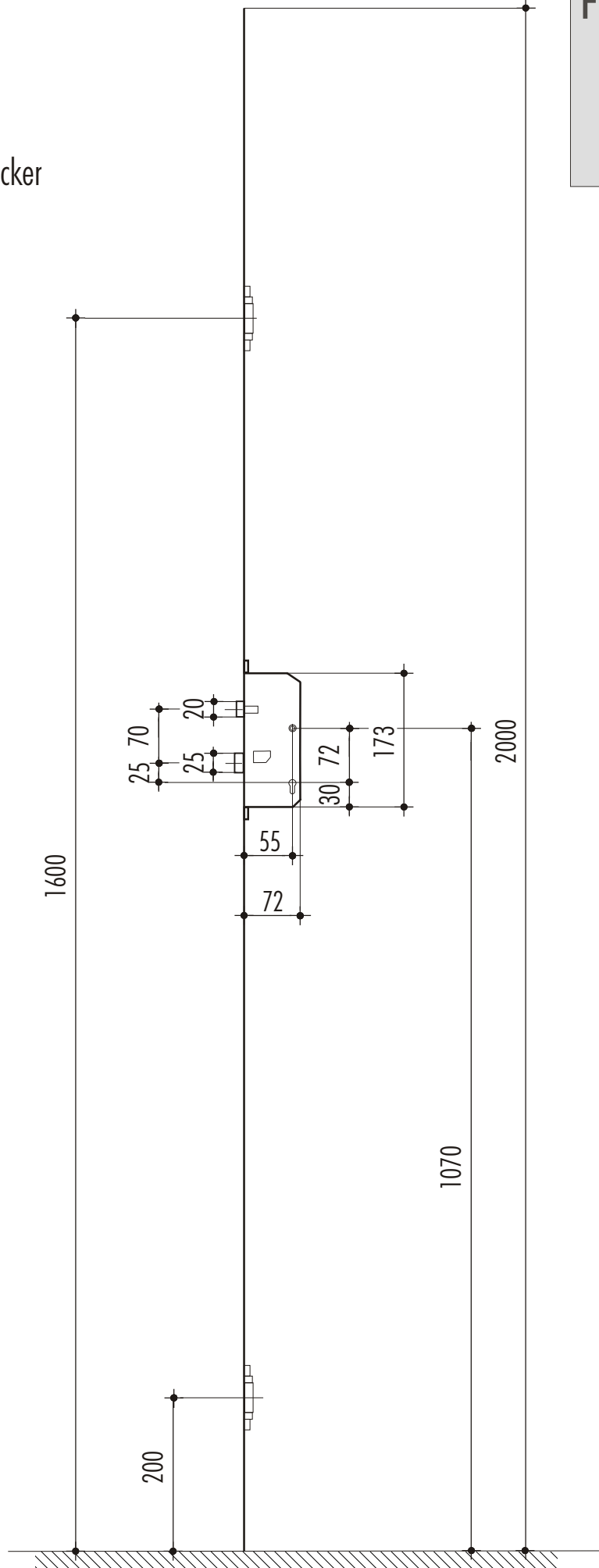
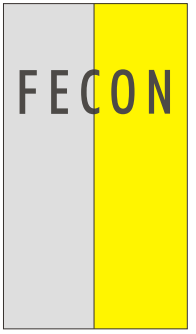

## Typ OHA u. OHI

Auf Wunsch dänisches  
Schlosse für dtsche.  
Wohnungs-Eingangsdrücker

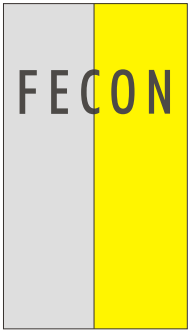

Türschild

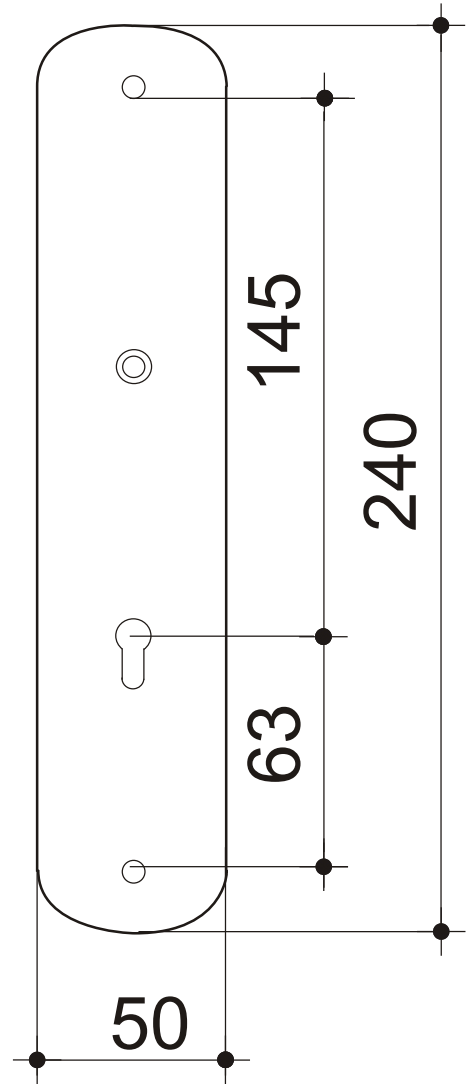
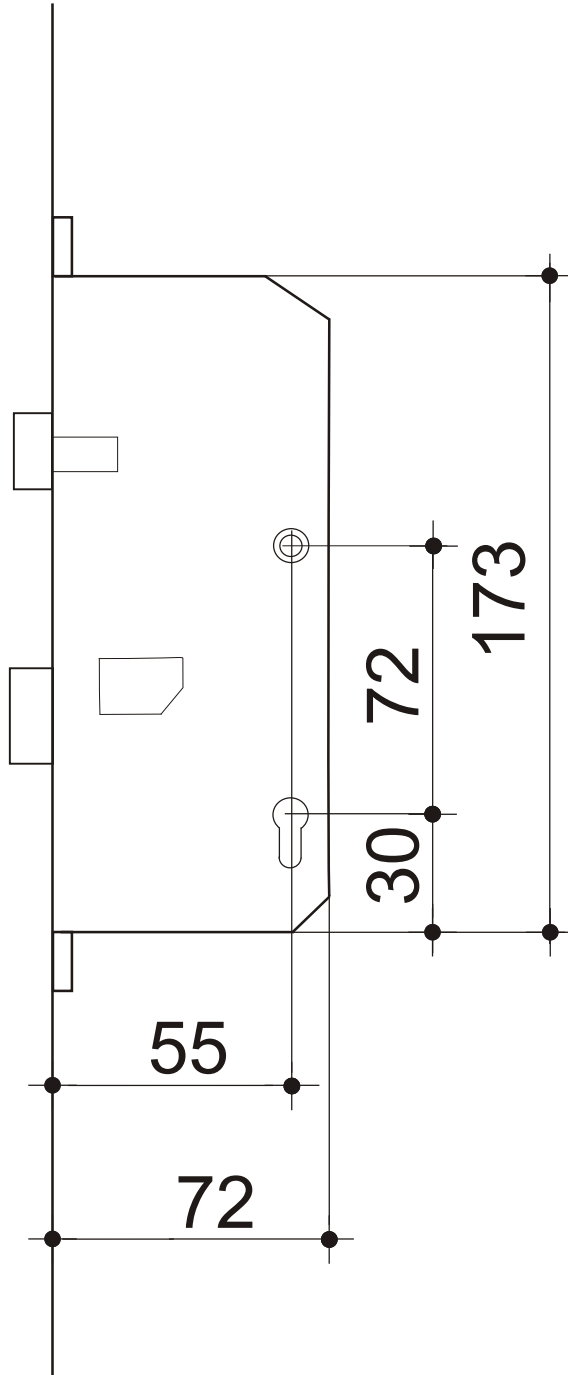

# Typ OF

Das Dänische Fenster auswärtsschlagend

Eckpfosten

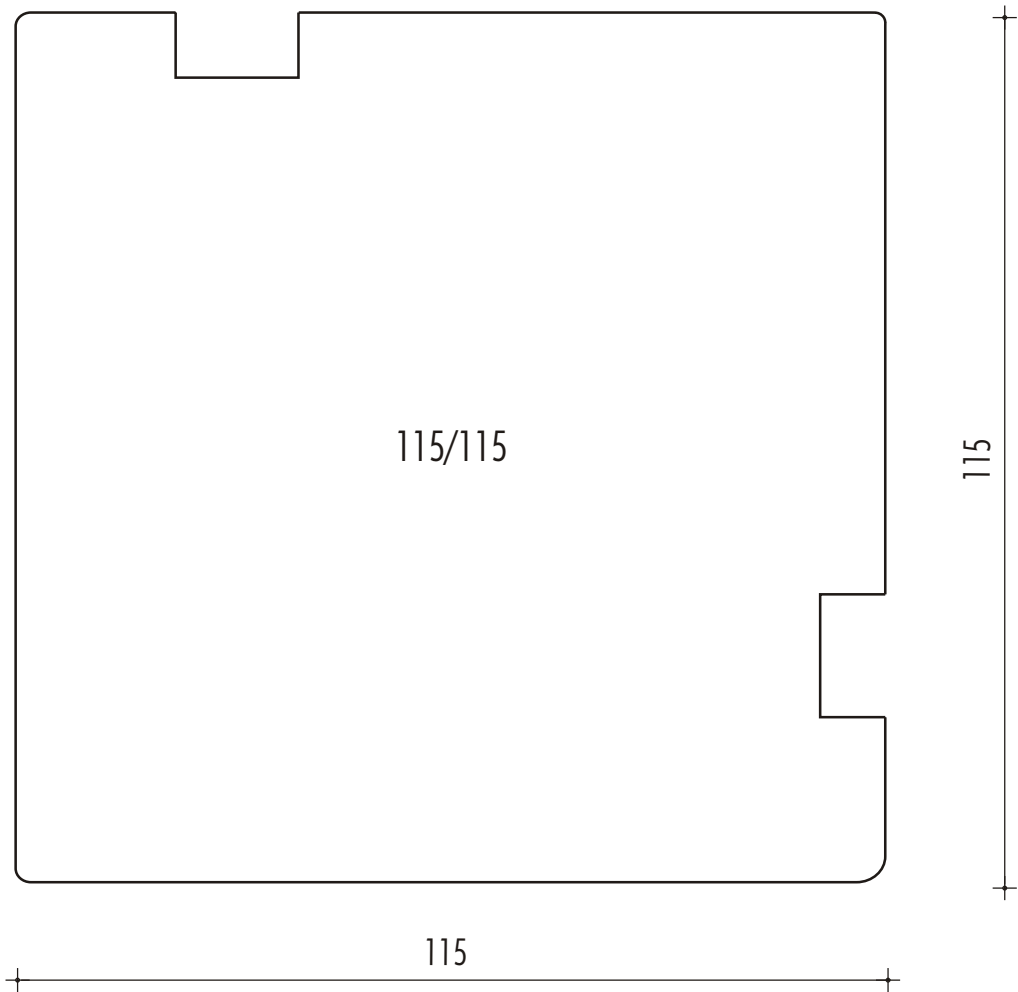
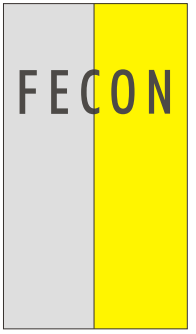



# Classic - fyrretræ

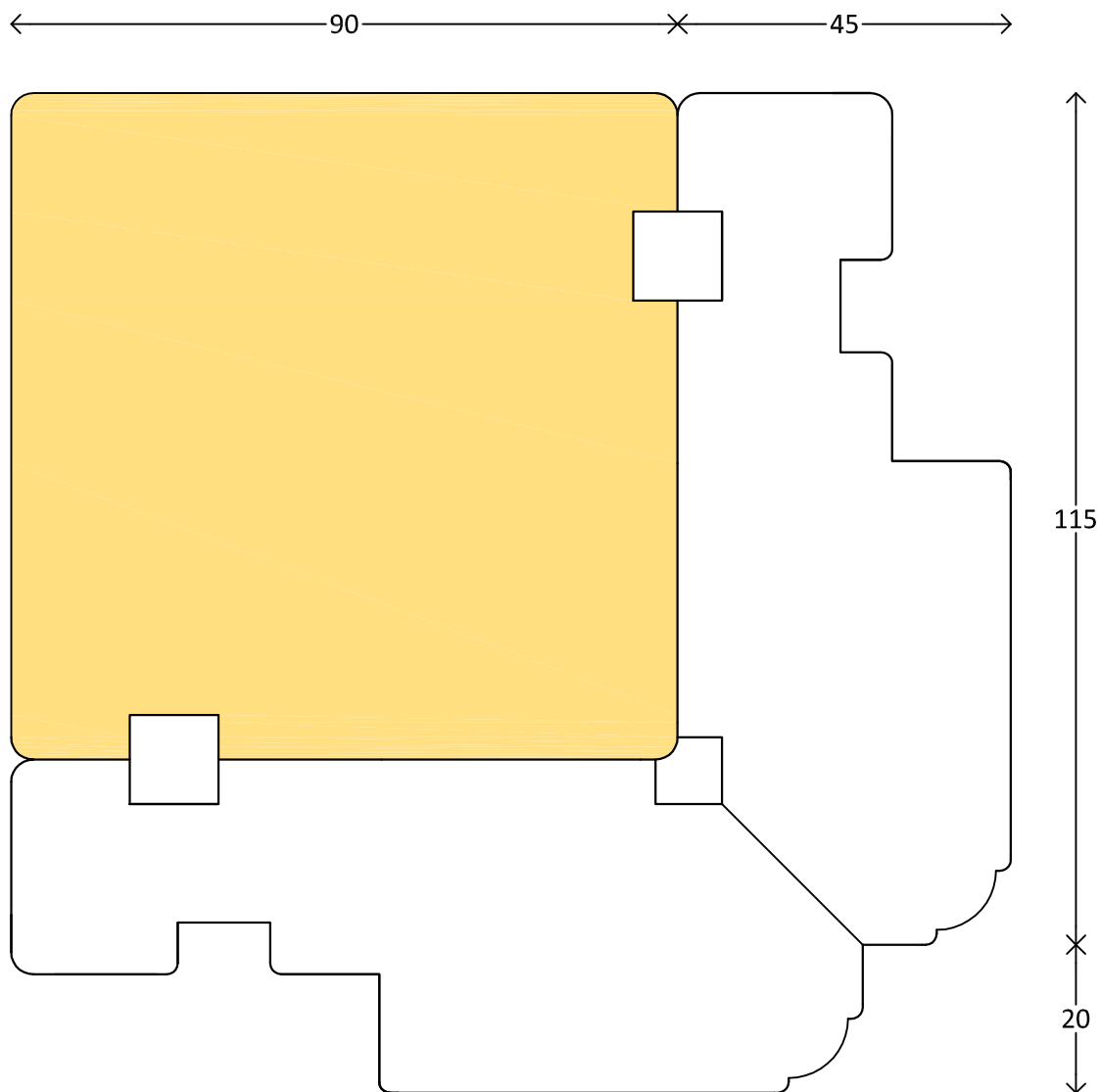

90° Hjørnestolpe  
Smigskårne karme

Profil : Pynte profil  
Tegning : HJSc-41  
Oprettet : 06-06-11  
Rev.nr. : 01

# Typ OF

Das Dänische Fenster auswärtsschlagend

Rahmenaufdoppelungen

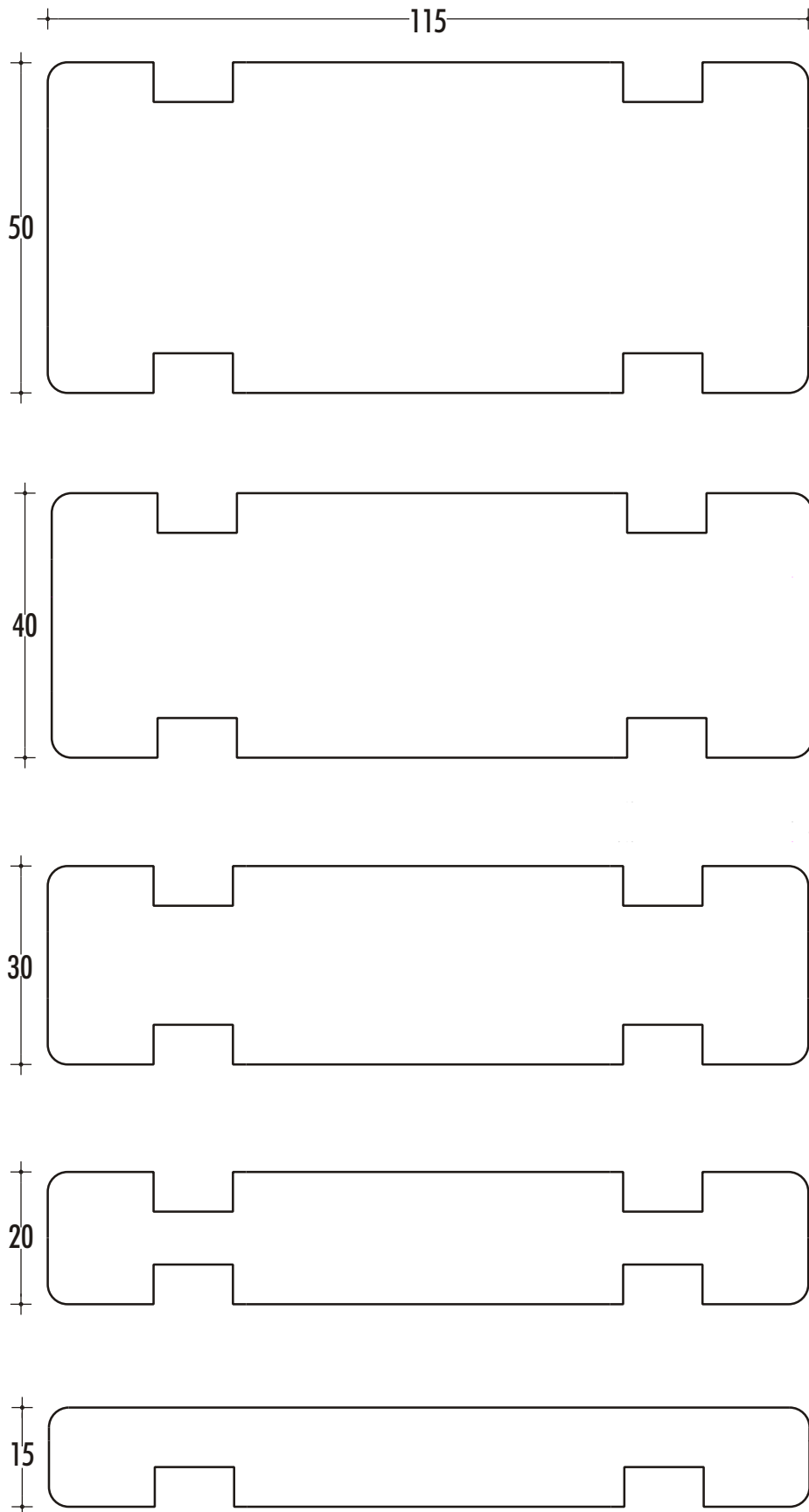
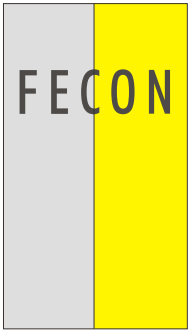

# Typ OF

Das Dänische Fenster auswärtsschlagend

Zarge seitlich, Kopplung -  
Empfehlung zur Montage

